

# ARIELTECH<sup>®</sup>

MANUFACTURER OF ENCLOSURE CLIMATE CONTROL SOLUTIONS

**FAN FILTERS | EXHAUST FILTERS | AXIAL FANS | HEATERS  
THERMOSTATS | HYGROSTAT | THERMOELECTRIC COOLING UNITS**

CLIMATE  
CONTROL  
SOLUTIONS

CATALOG



**Ariel Technology Inc.**

9-1111 Gorham St., Newmarket, Ontario, Canada L3Y 8X8

Tel: 1-905-895-5900 • Fax: 1-905-895-5960 • (USA/Canada) Toll Free 1-855-895-5900 • [info@arieltech.ca](mailto:info@arieltech.ca)

[www.arieltech.ca](http://www.arieltech.ca)

---

# INDEX

---

Fan Filters  
Exhaust Filters

**04**

Axial Fans

**24**

Mechanical Thermostats  
Normally Open & Normally Closed

**26**

Humidity Control  
Mechanical Hygrostat

**28**

Heaters

**30**

Thermoelectric  
Cooling Units

**32**

Warranty

**35**



# ABOUT ARIELTECH

Manufacturers of control panel and electrical enclosure Climate Control solutions.

Arieltech is more than just dedicated to giving you the very best solutions that will keep your control panels warm, cool, or dry. We are innovators, we bring new and innovative industrial climate control solutions to the market that are driven by the needs of our valued customers.

Lead by a team of professional engineers, sales and marketing teams with a combined 80+ years of industrial experience, and a customer-focused approach.

## **We serve customers all over the world.**

Our facility is nestled just north of Toronto and is our state-of-the-art design, engineering, manufacturing, sales, and assembly hub. We manufacture a complete line of climate control solutions that will exceed your expectations.

## **Mission Statement**

Make the best quality climate control products, innovate and exceed our customer's expectations



# Fan Filters and Exhaust Filters

## FTEC Series

FTEC

### Certificates

- UL and cUL Listed, File Number E497874
- CSA and CSAus Listed, File Number 80030884
- CE Compliant

### Application

FTEC series Fan Filters and Exhaust Filters are designed to supply forced convection filtered air for enclosures and electrical panels. By using the unique filtering and cooling features, FTEC will cool down the inside of enclosures to a desired temperature to protect the electrical and electronic parts against heat.

### Features

- Type 12 and Type 3R NEMA Rating-NO HOOD REQUIRED
- IP 54 using G3 filter mat and IP 55 using G4 filter mat
- 115 VAC, 230 VAC, 460 VAC, 12, 24, and 48 VDC available
- Flow capacity from 15 CFM to 625 CFM (26 m<sup>3</sup>/hr to 1060 m<sup>3</sup>/hr)
- Polyurethane sealing gasket
- Ball bearing Fan
- Easily snaps into place without the use of screws
- Washable and reusable filter mat
- Robust flame-retardant plastic housing, UL 94-V0
- Operating/Storage Temperature: -4 °F to +158 °F / -20 °C to +70 °C
- Durability: 50,000 hrs
- UV Resistant

### Colors

- RAL 7035 – Light Gray
- RAL 7032 – Dark Gray
- RAL 9011 – Black
- Custom Colors upon request



# Selection Chart - Fan Filters and Exhaust Filters

Model No.		Size	Voltage	NEMA Rating	Type Rating	Unimpeded Flow Capacity	In combination Flow Capacity	Certificates				
		Inch-mm	VAC/VDC			CFM-m <sup>3</sup> /hr	CFM-m <sup>3</sup> /hr					
FTEC10(*)4X	Exhaust Filter	4-110X110	-	TYPE 12	IP 54	-	-	UL-CSA-CE				
FTEC10(*)4X-115SB	Fan Filter		115 AC			15-26	11-19	UL-CSA-CE				
FTEC10(*)4X-230SB			230 AC			15-26	11-19	UL-CSA-CE				
FTEC10(*)4X-(**)SB			12/24/48 DC			38-65	26-45	UL-CSA-CE				
FTEC10(*)5(***)	Exhaust Filter		-	TYPE 3R	IP 55	-	-	UL-CSA-CE				
FTEC10(*)5(***)-115SB	Fan Filter		115 AC			14-24	10-17	UL-CSA-CE				
FTEC10(*)5(***)-230SB			230 AC			14-24	10-17	UL-CSA-CE				
FTEC10(*)5(***)-(**)SB			12/24/48 DC			35-60	22-37	UL-CSA-CE				
FTEC16(*)4X	Exhaust Filter		6-116X116	-	TYPE 12	IP 54	-	-	UL-CSA-CE			
FTEC16(*)4X-115SB	Fan Filter			115 AC			42-70	35-60	UL-CSA-CE			
FTEC16(*)4X-230SB				230 AC			42-70	35-60	UL-CSA-CE			
FTEC16(*)4X-(**)SB				12/24/48 DC			42-70	35-60	UL-CSA-CE			
FTEC16(*)5(***)	Exhaust Filter	-		TYPE 3R	IP 55	-	-	UL-CSA-CE				
FTEC16(*)5(***)-115SB	Fan Filter	115 AC				35-60	30-50	UL-CSA-CE				
FTEC16(*)5(***)-230SB		230 AC				35-60	30-50	UL-CSA-CE				
FTEC16(*)5(***)-(**)SB		12/24/48 DC				35-60	30-50	UL-CSA-CE				
FTEC20(*)4X	Exhaust Filter	8-206X206		-	TYPE 12	IP 54	-	-	UL-CSA-CE			
FTEC20(*)4X-115SB	Fan Filter			115 AC			95-160	70-120	UL-CSA-CE			
FTEC20(*)4X-230SB				230 AC			95-160	70-120	UL-CSA-CE			
FTEC20(*)4X-(**)SB				12/24/48 DC			90-152	70-120	UL-CSA-CE			
FTEC20(*)5(***)	Exhaust Filter		-	TYPE 3R	IP 55	-	-	UL-CSA-CE				
FTEC20(*)5(***)-115SB	Fan Filter		115 AC			80-135	60-100	UL-CSA-CE				
FTEC20(*)5(***)-230SB			230 AC			80-135	60-100	UL-CSA-CE				
FTEC20(*)5(***)-(**)SB			12/24/48 DC			76-128	57-97	UL-CSA-CE				
FTEC26(*)4X	Exhaust Filter		10-260X260	-	TYPE 12	IP 54	-	-	UL-CSA-CE			
FTEC26(*)4X-115SBS	Fan Filter			115 AC			137-230	120-205	UL-CSA-CE			
FTEC26(*)4X-230SBS				230 AC			137-230	120-205	UL-CSA-CE			
FTEC26(*)4X-(**)SBS				12/24/48 DC			130-220	115-195	UL-CSA-CE			
FTEC26(*)4X-115SB		115 AC		165-280			147-250	UL-CSA-CE				
FTEC26(*)4X-230SB		230 AC		165-280			147-250	UL-CSA-CE				
FTEC26(*)4X-(**)SB		12/24/48 DC		170-290			150-255	UL-CSA-CE				
FTEC26(*)4X-115SBB	Fan Filter	115 AC		230-390			182-310	UL-CSA-CE				
FTEC26(*)4X-230SBB		230 AC		230-390			182-310	UL-CSA-CE				
FTEC26(*)5(***)		Fan Filter		-			TYPE 3R	IP 55	-	-	UL-CSA-CE	
FTEC26(*)5(***)-115SBS				115 AC					130-220	100-170	UL-CSA-CE	
FTEC26(*)5(***)-230SBS				230 AC					130-220	100-170	UL-CSA-CE	
FTEC26(*)5(***)-(**)SBS				12/24/48 DC	117-200	105-180			UL-CSA-CE			
FTEC26(*)5(***)-115SB	115 AC			150-255	130-220	UL-CSA-CE						
FTEC26(*)5(***)-230SB	230 AC			150-255	130-220	UL-CSA-CE						
FTEC26(*)5(***)-(**)SB	12/24/48 DC			155-265	137-230	UL-CSA-CE						
FTEC26(*)5(***)-115SBB	115 AC			190-325	153-260	UL-CSA-CE						
FTEC26(*)5(***)-230SBB	230 AC			190-325	153-260	UL-CSA-CE						
FTEC32(*)4X	Exhaust Filter			12-326X326	-	TYPE 12			IP 54	-	-	UL-CSA-CE
FTEC32(*)4X-115SB	Fan Filter				115 AC					380-645	220-375	UL-CSA-CE
FTEC32(*)4X-230SB					230 AC					380-645	220-375	UL-CSA-CE
FTEC32(*)4X-(**)SB		48 DC			550-935		330-560	UL-CSA-CE				
FTEC32(*)4X-115SBB		115 AC			450-765		290-492	UL-CSA-CE				
FTEC32(*)4X-230SBB		230 AC			450-765		290-492	UL-CSA-CE				
FTEC32(*)4X-115SBG		115 AC	625-1060		430-730		UL-CSA-CE					
FTEC32(*)4X-230SBG		230 AC	625-1060		430-730		UL-CSA-CE					
FTEC32(*)4X-440SBG		460 AC	625-1060		430-730		UL-CSA-CE					
FTEC32(*)5(***)	Exhaust Filter	-	TYPE 3R		IP 55		-	-		UL-CSA-CE		
FTEC32(*)5(***)-115SB	Fan Filter	115 AC					350-595	190-320		UL-CSA-CE		
FTEC32(*)5(***)-230SB		230 AC					350-595	190-320		UL-CSA-CE		
FTEC32(*)5(***)-(**)SB		48 DC				500-850	280-475	UL-CSA-CE				
FTEC32(*)5(***)-115SBB		115 AC				418-712	235-400	UL-CSA-CE				
FTEC32(*)5(***)-230SBB		230 AC				418-712	235-400	UL-CSA-CE				
FTEC32(*)5(***)-115SBG		115 AC				595-1010	420-715	UL-CSA-CE				
FTEC32(*)5(***)-230SBG		230 AC				595-1010	420-715	UL-CSA-CE				
FTEC32(*)5(***)-440SBG		460 AC				595-1010	420-715	UL-CSA-CE				

(\*) L means RAL 7035 Light Grey, D means RAL 7032 Dark Grey, B means RAL 9011 Black, and O means Optional colors  
 (\*\*\*) 12D means 12 VDC, 24D means 24 VDC, and 48D means 48 VDC  
 (\*\*) X represents Type 12, IP 54 or IP 55 and Z represents Type 3R, IP 55, all airflow are at 60 Hz.



# FTEC 10 SERIES

FTEC10 series Performance Chart - 4" Fan Filter and Exhaust Filter

NEMA Rating	Type 12			Type 3R		
	IP 54			IP 55		
Filter Media	G3					
Rated Voltage	115 VAC	230 VAC	12/24/48 VDC	115 VAC	230 VAC	12/24/48 VDC
Frequency	60/50 Hz	60/50 Hz		60/50 Hz	60/50 Hz	
Bearing	Ball Bearing	Ball Bearing	Ball Bearing	Ball Bearing	Ball Bearing	Ball Bearing
Power connection	2 Poles Terminal & Ground		Wires	2 Poles Terminal & Ground		Wires
<b>Fan Filters Colors</b>						
RAL 7035 Light Gray	FTEC10L4X-115SB	FTEC10L4X-230SB	FTEC10L4X-(*)DSB	FTEC10L5(**)-115SB	FTEC10L5(**)-230SB	FTEC10L5(**)-(*)DSB
RAL 7032 Dark Gray	FTEC10D4X-115SB	FTEC10D4X-230SB	FTEC10D4X-(*)DSB	FTEC10D5(**)-115SB	FTEC10D5(**)-230SB	FTEC10D5(**)-(*)DSB
RAL 9011 Black	FTEC10B4X-115SB	FTEC10B4X-230SB	FTEC10B4X-(*)DSB	FTEC10B5(**)-115SB	FTEC10B5(**)-230SB	FTEC10B5(**)-(*)DSB
<b>Flow Capacity (CFM-m<sup>3</sup>/hr at 60/50 Hz) and Maximum Static Pressure (in H<sub>2</sub>O-Pa at 60/50 Hz)</b>						
Unimpeded	15/14-26/24	15/14-26/24	38-65	14/11-24/19	14/11-24/19	35-60
<b>In combination</b>						
Fan Filter+Exhaust Filter	11/9-19/16	11/9-19/16	26-45	10/8-17/14	10/8-17/14	22-37
Max. Static Pressure	0.18/0.13-46/33	0.18/0.13-46/33	0.32-80	0.15/0.12-37/30	0.15/0.12-37/30	0.30-75
Fan Filter+Reverse Flow Fan Filter	13/12-22/20	13/12-22/20	35-60	12/11-20/19	12/11-20/19	32-55
Max. Static Pressure	0.20/0.16-50/40	0.20/0.16-50/40	0.34-85	0.18/0.14-46/35	0.18/0.14-46/35	0.31-78
<b>Other Fan Filters Data</b>						
Rated Current (A)	0.13/0.18 ± 10%	0.09/0.12 ± 10%	0.9/0.4/0.2	0.13/0.18 ± 10%	0.09/0.12 ± 10%	0.9/0.4/0.2
Weight (gr/lb)	450/1			450/1		
Noise Level (dB(A))	38/33		55	38/33		55
Durability (hrs at 25 °C)	50,000	50,000	50,000	50,000	50,000	50,000
Operating Temperature (°C/°F)	-20 to +70 / -4 to +158			-20 to +70 / -4 to +158		
Dimensions	4.57" X 4.57" X 2.95" / 116 X 116 X 75 mm <sup>3</sup>			4.57" X 4.57" X 2.95" / 116 X 116 X 75 mm <sup>3</sup>		
Certificates	CSA-UL-CE			CSA-UL-CE		
<b>Exhaust Filter-Colors</b>						
	Type 12-IP 54			Type 3R-IP55		
RAL 7035 Light Gray	FTEC10L4X			FTEC10L5(**)		
RAL 7032 Dark Gray	FTEC10D4X			FTEC10D5(**)		
RAL 9011 Black	FTEC10B4X			FTEC10B5(**)		
Dimensions	4.57" X 4.57" X 1.22" / 116 X 116 X 31 mm <sup>3</sup>			4.57" X 4.57" X 1.22" / 116 X 116 X 31 mm <sup>3</sup>		
Weight (gr/lb)	100/0.22			100/0.22		
Certificates	CSA-UL-CE			CSA-UL-CE		
<b>Accessories</b>						
Replacement Filter Media	FTEC10-FM-4			FTEC10-FM-5		
NO Thermostat (°C)	TTEC-200-C		-	TTEC-200-C		-
NO Thermostat (°F)	TTEC-200-F		-	TTEC-200-F		-

(\*) 12 means 12 VDC, 24 means 24 VDC, and 48 means 48 VDC

(\*\*) X represents Type 12, IP 54 or IP 55, Z represents Type 3R IP 55

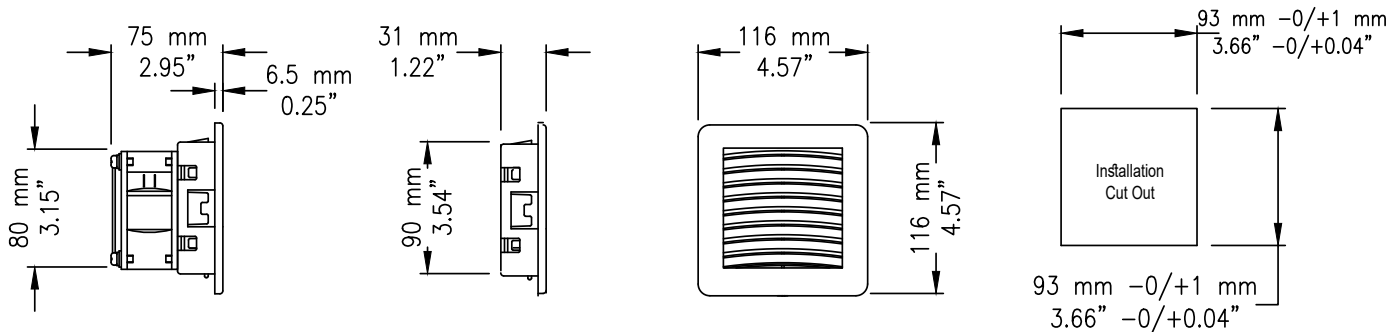
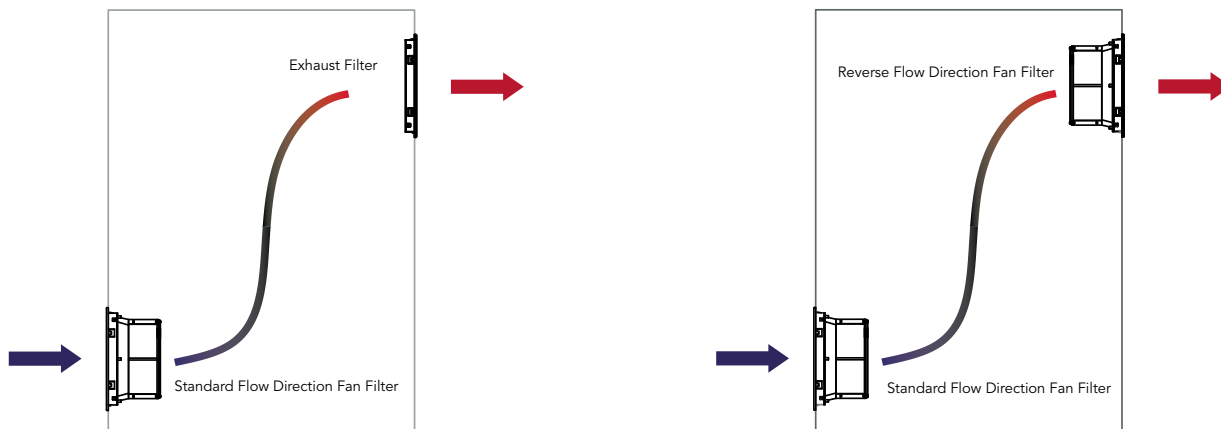

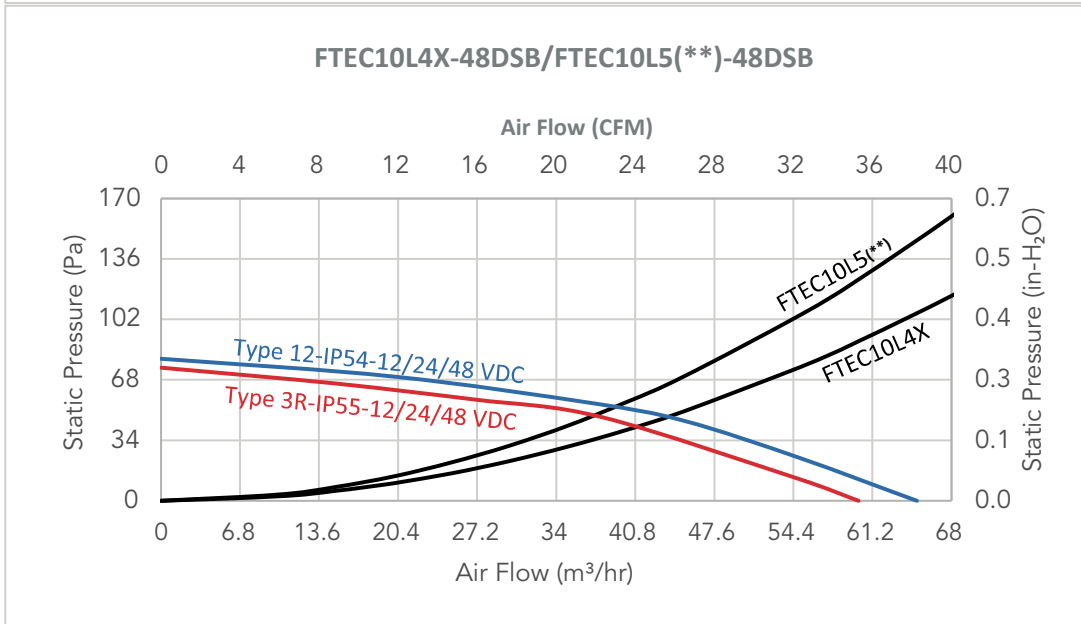
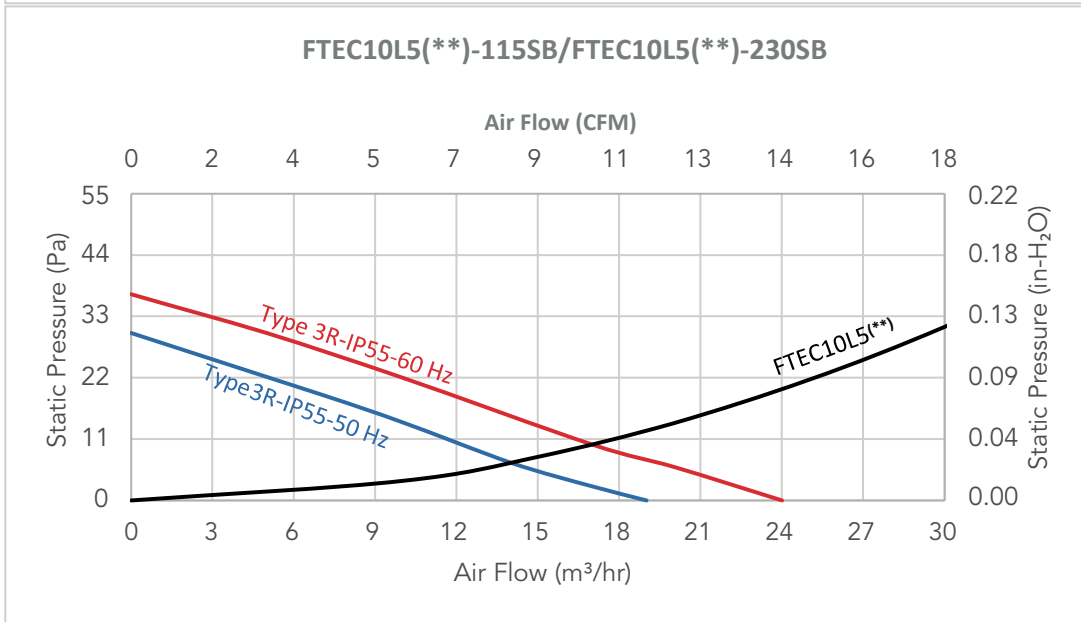
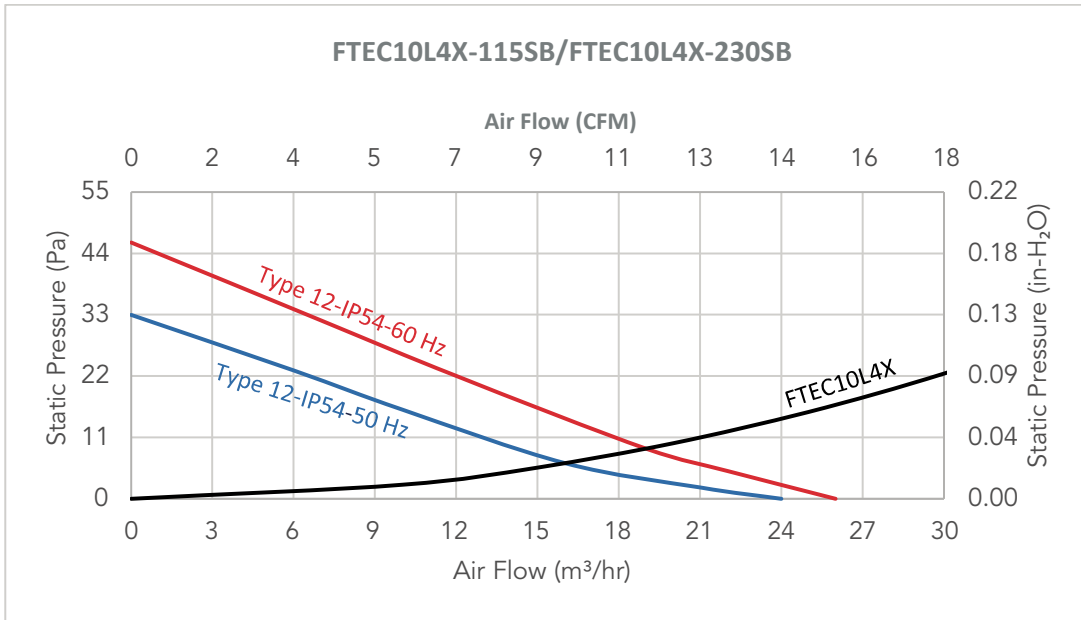

# FTEC 16 SERIES

FTEC16 series Performance Chart - 6" Fan Filter and Exhaust Filter

		Type 12			Type 3R		
NEMA Rating		Type 12			Type 3R		
IP Rating		IP 54			IP 55		
Filter Media		G3			G4		
Rated Voltage		115 VAC	230 VAC	12/24/48 VDC	115 VAC	230 VAC	12/24/48 VDC
Frequency		60/50 Hz	60/50 Hz		60/50 Hz	60/50 Hz	
Bearing		Ball Bearing	Ball Bearing	Ball Bearing	Ball Bearing	Ball Bearing	Ball Bearing
Power connection		2 Poles Terminal & Ground			2 Poles Terminal & Ground		
Fan Filters Colors							
RAL 7035 Light Gray		FTEC16L4X-115SB	FTEC16L4X-230SB	FTEC16L4X-(*)DSB	FTEC16L5(**)-115SB	FTEC16L5(**)-230SB	FTEC16L5(**)-(*)DSB
RAL 7032 Dark Gray		FTEC16D4X-115SB	FTEC16D4X-230SB	FTEC16D4X-(*)DSB	FTEC16D5(**)-115SB	FTEC16D5(**)-230SB	FTEC16D5(**)-(*)DSB
RAL 9011 Black		FTEC16B4X-115SB	FTEC16B4X-230SB	FTEC16B4X-(*)DSB	FTEC16B5(**)-115SB	FTEC16B5(**)-230SB	FTEC16B5(**)-(*)DSB
Flow Capacity (CFM-m <sup>3</sup> /hr at 60/50 Hz) and Maximum Static Pressure (in H <sub>2</sub> O-Pa at 60/50 Hz)							
Unimpeded		42/40-70/68	42/40-70/68	42-70	35/31-60/52	35/31-60/52	35-60
In combination							
Fan Filter+Exhaust Filter		35/32-60/55	35/32-60/55	35-60	30/28-50/47	30/28-50/47	30-50
Max. Static Pressure		0.32/0.28-80/70	0.32/0.28-80/70	0.38-95	0.30/0.27-75/68	0.30/0.27-75/68	0.30-75
Fan Filter+Reverse Flow Fan Filter		40/37-68/63	40/37-68/63	40-68	33/30-56/50	33/30-56/50	33-56
Max. Static Pressure		0.34/0.32-84/80	0.34/0.32-84/80	0.34-85	0.32/0.30-80/75	0.32/0.30-80/75	0.32-80
Other Fan Filters Data							
Rated Current (A)		0.22/0.26 ± 10%	0.11/0.13 ± 10%	1.35/0.85/0.32	0.22/0.26 ± 10%	0.11/0.13 ± 10%	1.35/0.85/0.32
Weight (gr/lb)		750/1.65			750/1.65		
Noise Level (dB(A))		45/41			45/41		
Durability (hrs at 25 °C)		50,000	50,000	50,000	50,000	50,000	50,000
Operating Temperature (°C/°F)		-20 to +70 / -4 to +158			-20 to +70 / -4 to +158		
Dimensions		6.3" X 6.3" X 3.01" / 160 X 160 X 76.5 mm <sup>3</sup>			6.3" X 6.3" X 3.01" / 160 X 160 X 76.5 mm <sup>3</sup>		
Certificates		CSA-UL-CE			CSA-UL-CE		
Exhaust Filter-Colors		Type 12-IP 54			Type 3R-IP55		
RAL 7035 Light Gray		FTEC16L4X			FTEC16L5(**)		
RAL 7032 Dark Gray		FTEC16D4X			FTEC16D5(**)		
RAL 9011 Black		FTEC16B4X			FTEC16B5(**)		
Dimensions		6.3" X 6.3" X 1.22" / 160 X 160 X 31 mm <sup>3</sup>			6.3" X 6.3" X 1.22" / 160 X 160 X 31 mm <sup>3</sup>		
Weight (gr/lb)		200/0.44			200/0.44		
Certificates		CSA-UL-CE			CSA-UL-CE		
Accessories							
Replacement Filter Media		FTEC16-FM-4			FTEC16-FM-5		
NO Thermostat (°C)		TTEC-200-C	-	-	TTEC-200-C	-	-
NO Thermostat (°F)		TTEC-200-F	-	-	TTEC-200-F	-	-

(\*) 12 means 12 VDC, 24 means 24 VDC, and 48 means 48 VDC  
 (\*\*) X represents Type 12, IP 54 or IP 55, Z represents Type 3R IP 55

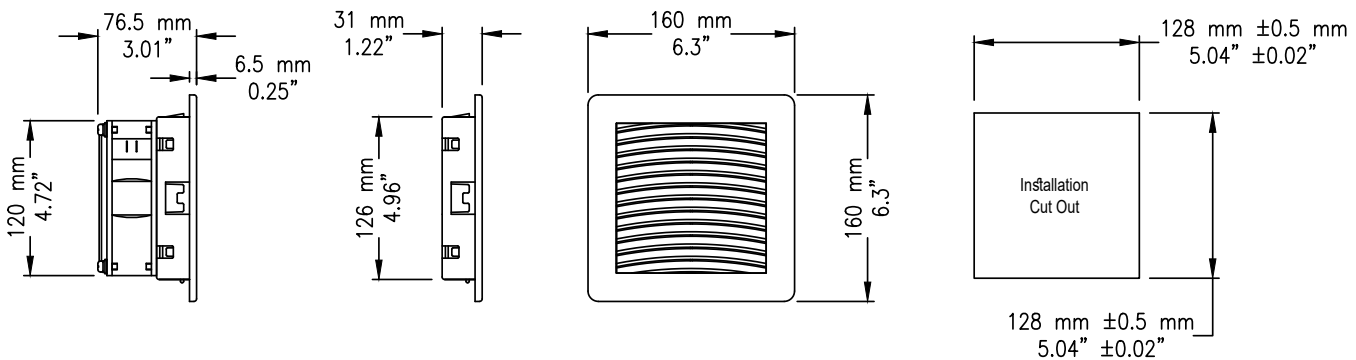
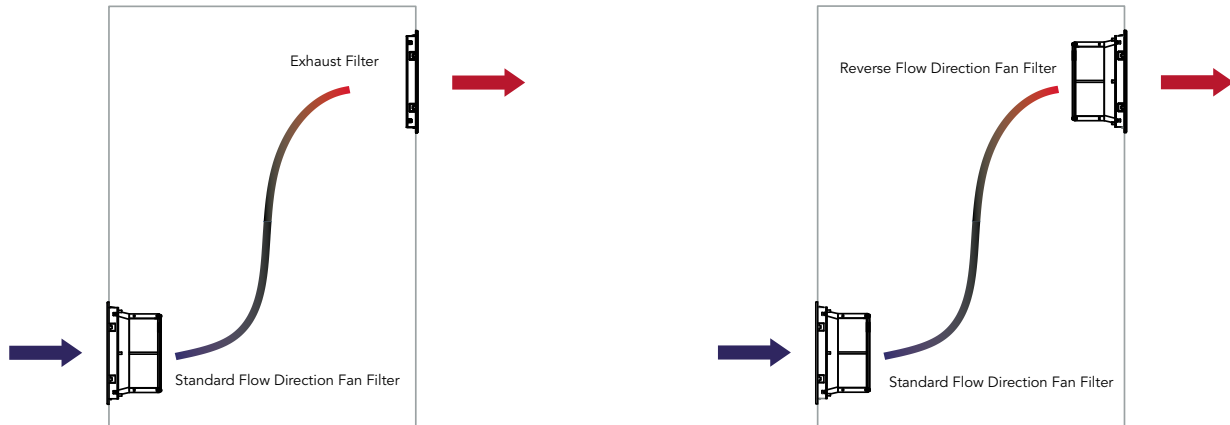



**FTEC16L4X-115SB/FTEC16L4X-230SB**

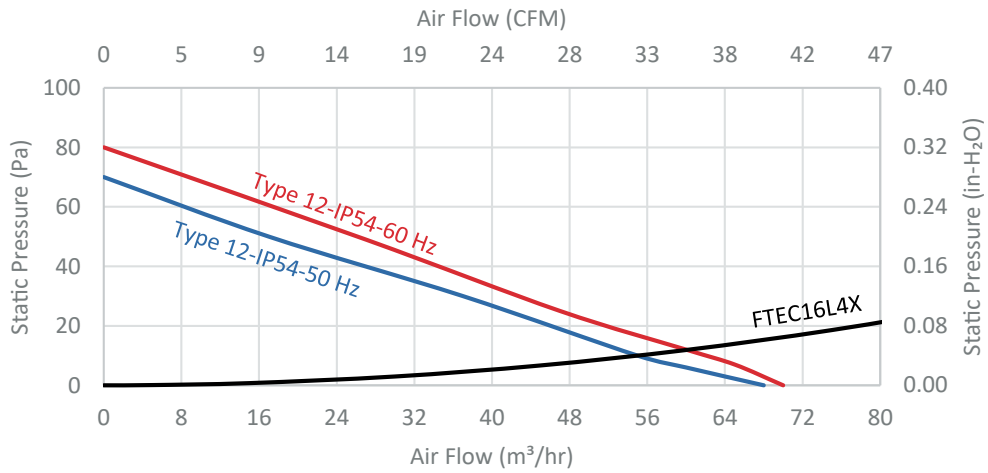

**FTEC16L5(\*\*)-115SB/FTEC16L5(\*\*)-230SB**

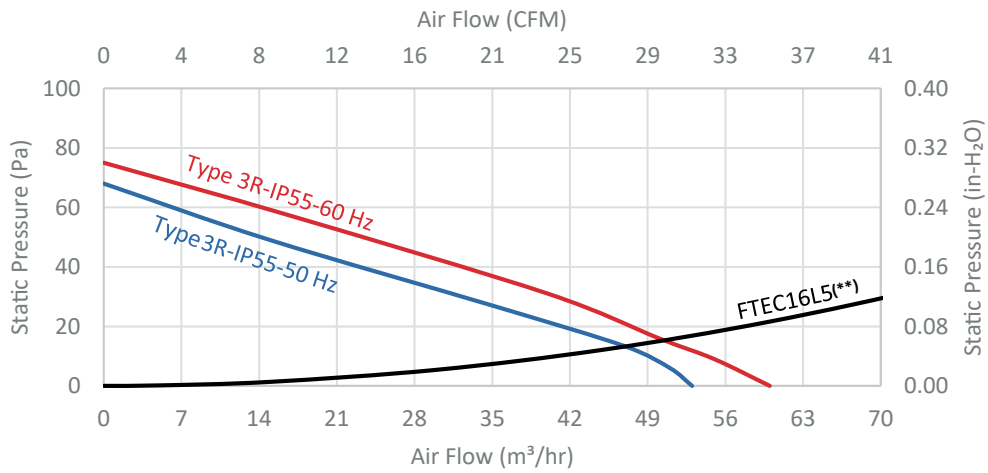

**FTEC16L4X-48DSB/FTEC16L5(\*\*)-48DSB**

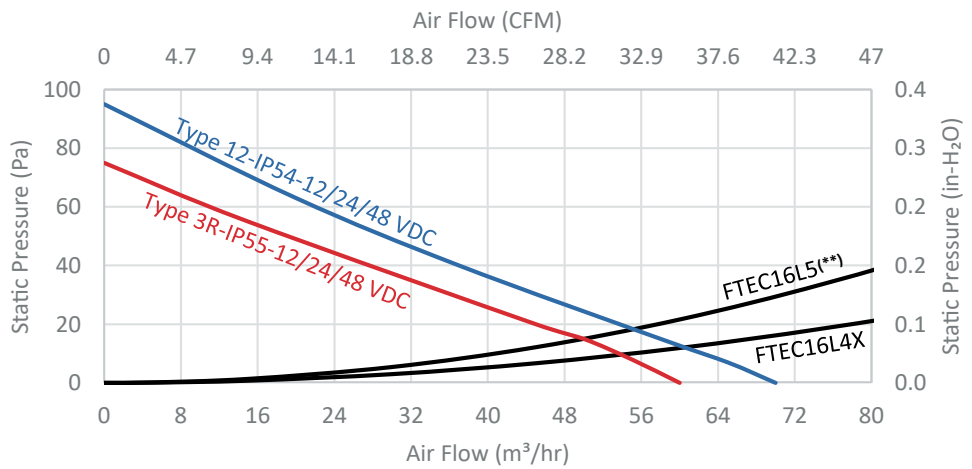

# FTEC 20 SERIES

FTEC20 series Performance Chart - 8" Fan Filter and Exhaust Filter

NEMA Rating	Type 12			Type 3R		
	IP 54			IP 55		
Filter Media	G3					
Rated Voltage	115 VAC	230 VAC	12/24/48 VDC	115 VAC	230 VAC	12/24/48 VDC
Frequency	60/50 Hz	60/50 Hz		60/50 Hz	60/50 Hz	
Bearing	Ball Bearing	Ball Bearing	Ball Bearing	Ball Bearing	Ball Bearing	Ball Bearing
Power connection	2 Poles Terminal & Ground			2 Poles Terminal & Ground		
Fan Filters Colors						
RAL 7035 Light Gray	FTEC20L4X-115SB	FTEC20L4X-230SB	FTEC20L4X-(*)DSB	FTEC20L5(**)-115SB	FTEC20L5(**)-230SB	FTEC20L5(**)-(*)DSB
RAL 7032 Dark Gray	FTEC20D4X-115SB	FTEC20D4X-230SB	FTEC20D4X-(*)DSB	FTEC20D5(**)-115SB	FTEC20D5(**)-230SB	FTEC20D5(**)-(*)DSB
RAL 9011 Black	FTEC20B4X-115SB	FTEC20B4X-230SB	FTEC20B4X-(*)DSB	FTEC20B5(**)-115SB	FTEC20B5(**)-230SB	FTEC20B5(**)-(*)DSB
Flow Capacity (CFM-m <sup>3</sup> /hr at 60/50 Hz) and Maximum Static Pressure (in H <sub>2</sub> O-Pa at 60/50 Hz)						
Unimpeded	95/90-160/152	95/90-160/152	90-152	80/76-135/128	80/76-135/128	76-128
In combination						
Fan Filter+Exhaust Filter	70/65-120/110	70/65-120/110	70-120	60/55-100/95	60/55-100/95	57-97
Max. Static Pressure	0.36/0.33-90/82	0.36/0.33-90/82	0.37-92	0.33/0.30-82/75	0.33/0.30-82/75	0.34-85
Fan Filter+Reverse Flow Fan Filter	80/75-135/127	80/75-135/127	77-130	70/65-120/110	70/65-120/110	67-115
Max. Static Pressure	0.39/0.34-96/85	0.39/0.34-96/85	0.40-100	0.35/0.33-87/82	0.35/0.33-87/82	0.36-90
Other Fan Filters Data						
Rated Current (A)	0.22/0.26 ± 10%	0.11/0.13 ± 10%	1.35/0.85/0.32	0.22/0.26 ± 10%	0.11/0.13 ± 10%	1.35/0.85/0.32
Weight (gr/lb)	950/2.1					
Noise Level (dB(A))	45/41			50		
Durability (hrs at 25 °C)	50,000	50,000	50,000	50,000	50,000	50,000
Operating Temperature (°C/°F)	-20 to +70 / -4 to +158			-20 to +70 / -4 to +158		
Dimensions	8.11" X 8.11" X 4.41" / 206 X 206 X 112 mm <sup>3</sup>			8.11" X 8.11" X 4.41" / 206 X 206 X 112 mm <sup>3</sup>		
Certificates	CSA-UL-CE			CSA-UL-CE		
Exhaust Filter-Colors	Type 12-IP 54			Type 3R-IP55		
RAL 7035 Light Gray	FTEC20L4X			FTEC20L5(**)		
RAL 7032 Dark Gray	FTEC20D4X			FTEC20D5(**)		
RAL 9011 Black	FTEC20B4X			FTEC20B5(**)		
Dimensions	8.11" X 8.11" X 1.22" / 206 X 206 X 31 mm <sup>3</sup>			8.11" X 8.11" X 1.22" / 206 X 206 X 31 mm <sup>3</sup>		
Weight (gr/lb)	300/0.66					
Certificates	CSA-UL-CE					
Accessories						
Replacement Filter Media	FTEC20-FM-4			FTEC20-FM-5		
NO Thermostat (°C)	TTEC-200-C	-	-	TTEC-200-C	-	-
NO Thermostat (°F)	TTEC-200-F	-	-	TTEC-200-F	-	-

(\*) 12 means 12 VDC, 24 means 24 VDC, and 48 means 48 VDC

(\*\*) X represents Type 12, IP 54 or IP 55, Z represents Type 3R IP 55

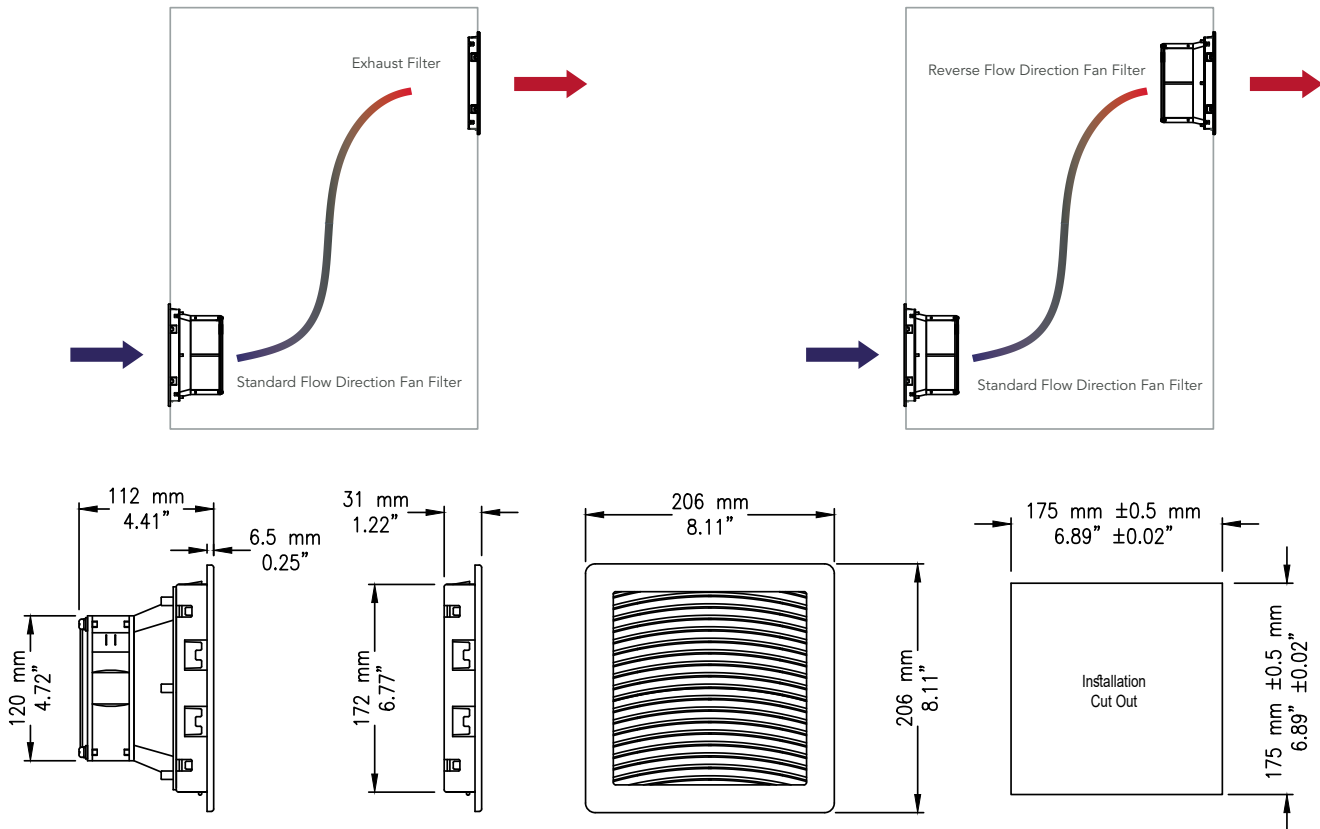

### FTEC20L4X-115SB/FTEC20L4X-230SB

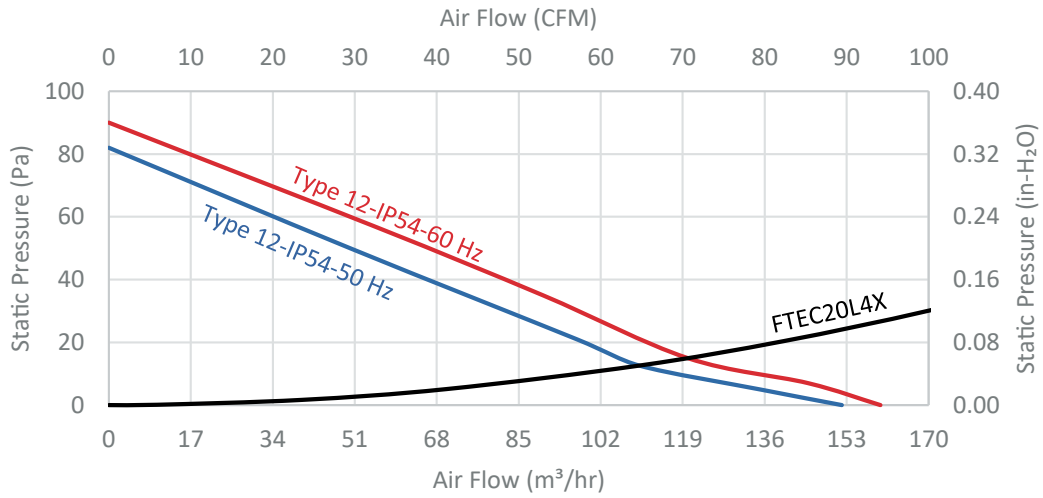

### FTEC20L5(\*\*)-115SB/FTEC20L5(\*\*)-230SB

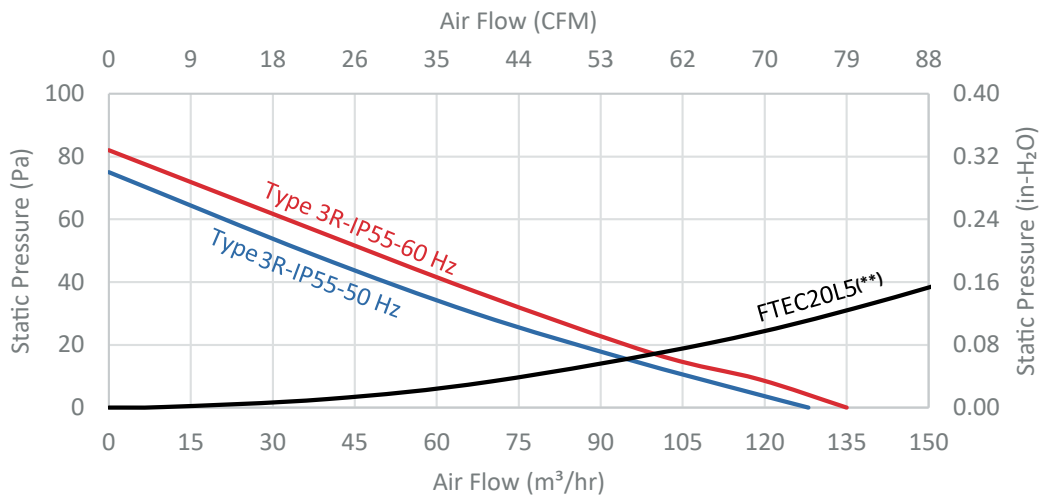

### FTEC20L4X-48DSB/FTEC20L5(\*\*)-48DSB

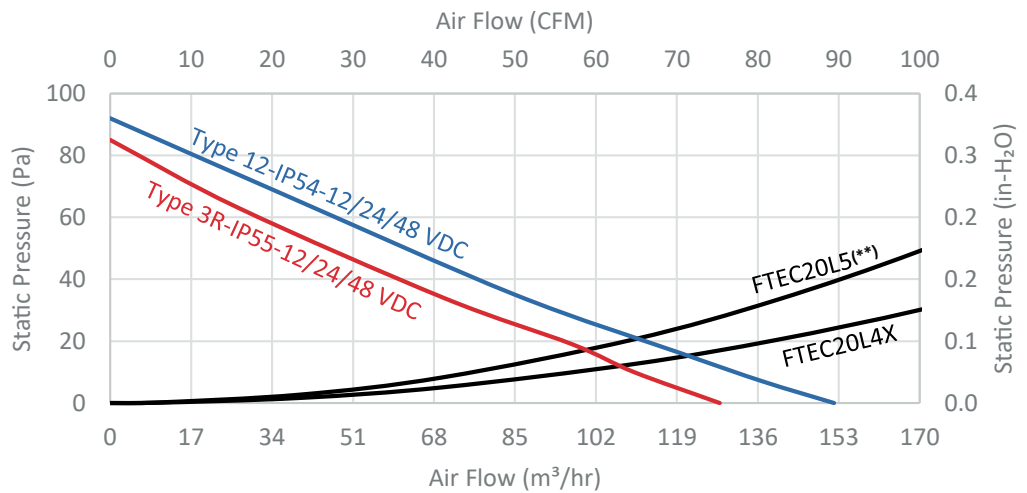

# FTEC 26S SERIES

FTEC26S series Performance Chart - 10" Fan Filter and Exhaust Filter

NEMA Rating	Type 12			Type 3R		
	IP 54			IP 55		
Filter Media	G3					
Rated Voltage	115 VAC	230 VAC	12/24/48 VDC	115 VAC	230 VAC	12/24/48 VDC
Frequency	60/50 Hz	60/50 Hz		60/50 Hz	60/50 Hz	
Bearing	Ball Bearing	Ball Bearing	Ball Bearing	Ball Bearing	Ball Bearing	Ball Bearing
Power connection	2 Poles Terminal & Ground			2 Poles Terminal & Ground		
Fan Filters Colors						
RAL 7035 Light Gray	FTEC26L4X-115SBS	FTEC26L4X-230SBS	FTEC26L4X-(*)DSBS	FTEC26L5(**)-115SBS	FTEC26L5(**)-230SBS	FTEC26L5(**)-(*)DSBS
RAL 7032 Dark Gray	FTEC26D4X-115SBS	FTEC26D4X-230SBS	FTEC26D4X-(*)DSBS	FTEC26D5(**)-115SBS	FTEC26D5(**)-230SBS	FTEC26D5(**)-(*)DSBS
RAL 9011 Black	FTEC26B4X-115SBS	FTEC26B4X-230SBS	FTEC26B4X-(*)DSBS	FTEC26B5(**)-115SBS	FTEC26B5(**)-230SBS	FTEC26B5(**)-(*)DSBS
Flow Capacity (CFM-m <sup>3</sup> /hr at 60/50 Hz) and Maximum Static Pressure (in H <sub>2</sub> O-Pa at 60/50 Hz)						
Unimpeded	137/130-230/220	137/130-230/220	130-220	130/125-220/210	130/125-220/210	117-200
In combination						
Fan Filter+Exhaust Filter	120/115-205/195	120/115-205/195	115-195	100/95-170/160	100/95-170/160	105-180
Max. Static Pressure	0.37/0.32-92/80	0.37/0.32-92/80	0.34-85	0.34/0.31-85/78	0.34/0.31-85/78	0.32-80
Fan Filter+Reverse Flow Fan Filter	130/125-220/210	130/125-220/210	120-205	120/115-205/195	120/115-205/195	107-182
Max. Static Pressure	0.40/0.36-100/90	0.40/0.36-100/90	0.36-90	0.34/0.31-89/82	0.34/0.31-89/82	0.34-85
Other Fan Filters Data						
Rated Current (A)	0.22/0.26 ± 10%	0.11/0.13 ± 10%	1.35/0.85/0.32	0.22/0.26 ± 10%	0.11/0.13 ± 10%	1.35/0.85/0.32
Weight (gr/lb)	1000/2.2			1000/2.2		
Noise Level (dB(A))	45/41			45/41		
Durability (hrs at 25 °C)	50,000	50,000	50,000	50,000	50,000	50,000
Operating Temperature (°C/°F)	-20 to +70 / -4 to +158			-20 to +70 / -4 to +158		
Dimensions	10.24" X 10.24" X 4.41" / 260X260X112 mm <sup>3</sup>			10.24" X 10.24" X 4.41" / 260X260X112 mm <sup>3</sup>		
Certificates	CSA-UL-CE			CSA-UL-CE		
Exhaust Filter-Colors	Type 12-IP 54			Type 3R-IP55		
RAL 7035 Light Gray	FTEC26L4X			FTEC26L5(**)		
RAL 7032 Dark Gray	FTEC26D4X			FTEC26D5(**)		
RAL 9011 Black	FTEC26B4X			FTEC26B5(**)		
Dimensions	10.24" X 10.24" X 1.22" / 260 X 260 X 31 mm <sup>3</sup>			10.24" X 10.24" X 1.22" / 260 X 260 X 31 mm <sup>3</sup>		
Weight (gr/lb)	450/1			450/1		
Certificates	CSA-UL-CE			CSA-UL-CE		
Accessories						
Replacement Filter Media	FTEC26-FM-4			FTEC26-FM-5		
NO Thermostat (°C)	TTEC-200-C	-	-	TTEC-200-C	-	-
NO Thermostat (°F)	TTEC-200-F	-	-	TTEC-200-F	-	-

(\*) 12 means 12 VDC, 24 means 24 VDC, and 48 means 48 VDC

(\*\*) X represents Type 12, IP 54 or IP 55, Z represents Type 3R IP 55

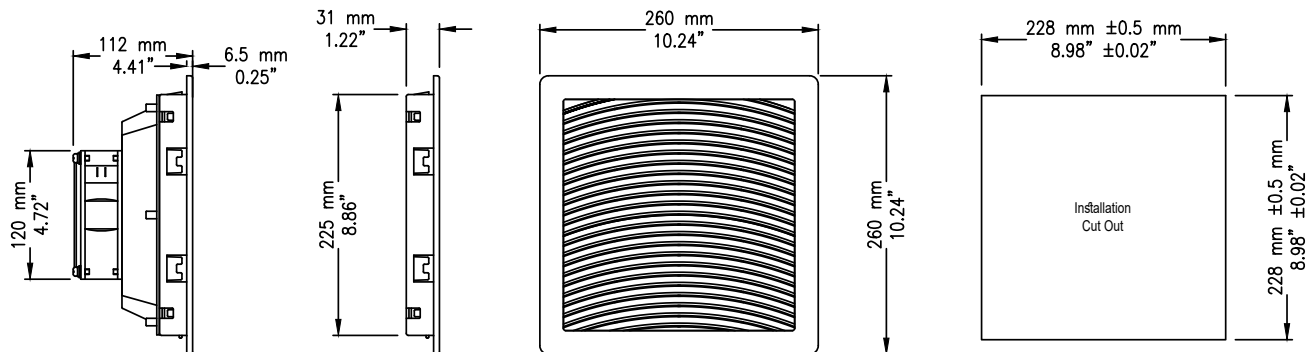
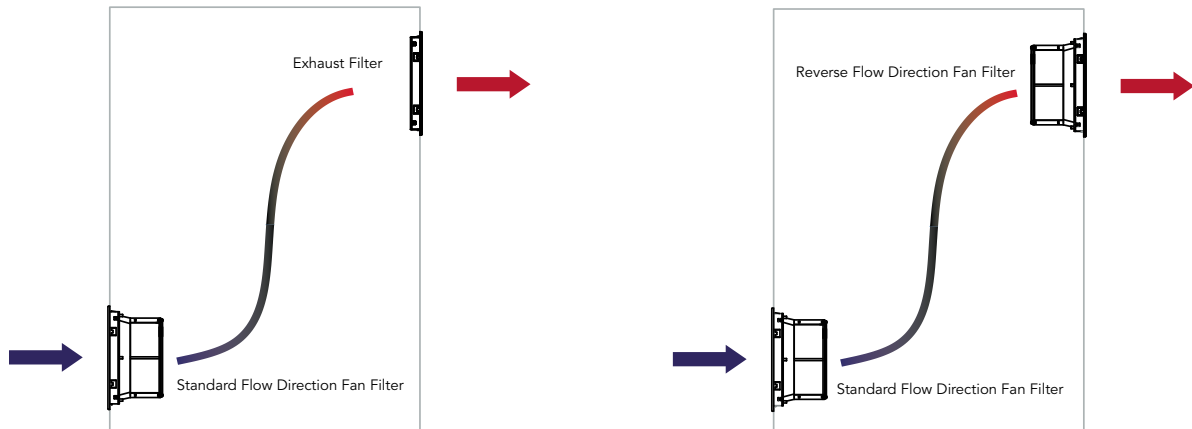

**FTEC26L4X-115SBS/FTEC26L4X-230SBS**

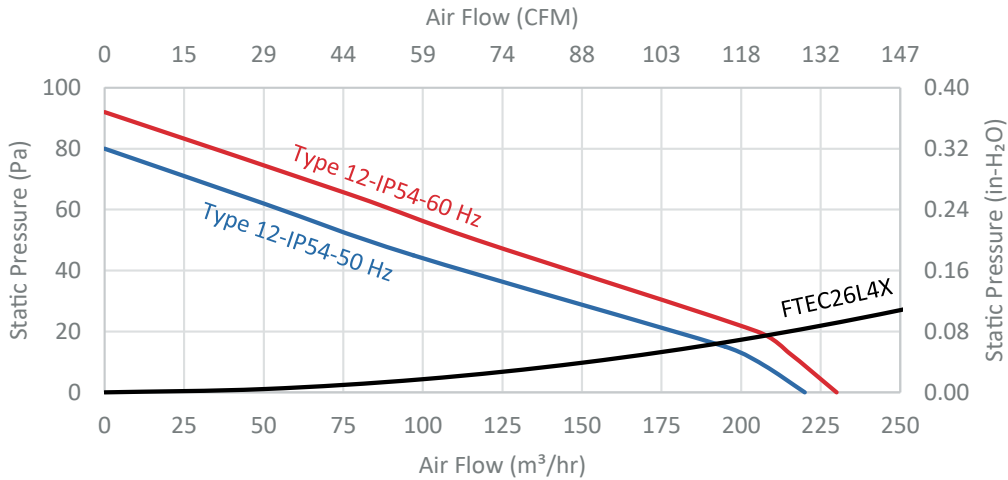

**FTEC26L5(\*\*)-115SBS/FTEC26L5(\*\*)-230SBS**

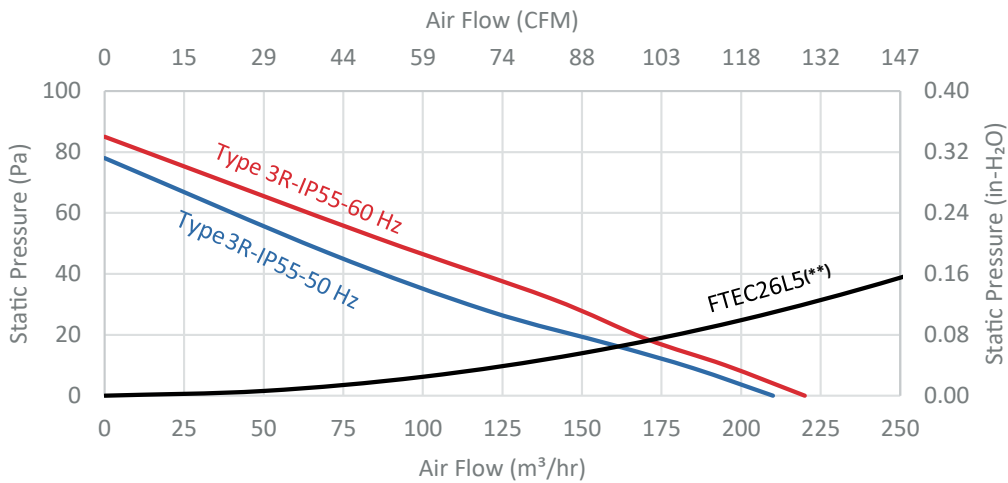

**FTEC26L4X-48DSBS/FTEC26L5(\*\*)-48DSBS**

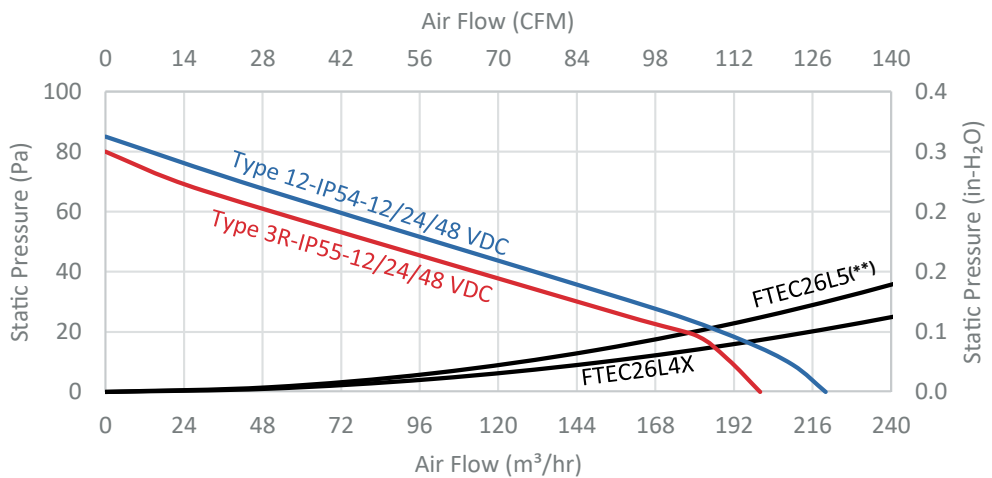

# FTEC 26 SERIES

FTEC26 series Performance Chart - 10" Fan Filter and Exhaust Filter

NEMA Rating	Type 12			Type 3R		
	IP 54			IP 55		
Filter Media	G3					
Rated Voltage	115 VAC	230 VAC	12/24/48 VDC	115 VAC	230 VAC	12/24/48 VDC
Frequency	60/50 Hz	60/50 Hz		60/50 Hz	60/50 Hz	
Bearing	Ball Bearing	Ball Bearing	Ball Bearing	Ball Bearing	Ball Bearing	Ball Bearing
Power connection	2 Poles Terminal & Ground			2 Poles Terminal & Ground		
Fan Filters Colors						
RAL 7035 Light Gray	FTEC26L4X-115SB	FTEC26L4X-230SB	FTEC26L4X-(*)DSB	FTEC26L5(**)-115SB	FTEC26L5(**)-230SB	FTEC26L5(**)-(*)DSB
RAL 7032 Dark Gray	FTEC26D4X-115SB	FTEC26D4X-230SB	FTEC26D4X-(*)DSB	FTEC26D5(**)-115SB	FTEC26D5(**)-230SB	FTEC26D5(**)-(*)DSB
RAL 9011 Black	FTEC26B4X-115SB	FTEC26B4X-230SB	FTEC26B4X-(*)DSB	FTEC26B5(**)-115SB	FTEC26B5(**)-230SB	FTEC26B5(**)-(*)DSB
Flow Capacity (CFM-m <sup>3</sup> /hr at 60/50 Hz) and Maximum Static Pressure (in H <sub>2</sub> O-Pa at 60/50 Hz)						
Unimpeded	165/155-280/265	165/155-280/265	170-290	150/140-255/237	150/140-255/237	155-265
In combination						
Fan Filter+Exhaust Filter	147/140-250/237	147/140-250/237	150-255	130/125-220/212	130/125-220/212	137-230
Max. Static Pressure	0.40/0.35-100/88	0.40/0.35-100/88	0.42/105	0.37/0.34-92/85	0.37/0.34-92/85	0.40-100
Fan Filter+Reverse Flow Fan Filter	155/150-265/255	155/150-265/255	160-270	140/133-237/225	140/133-237/225	147-250
Max. Static Pressure	0.46/0.43-115/107	0.46/0.43-115/107	0.48-120	0.42/0.40-105/100	0.42/0.40-105/100	0.44-110
Other Fan Filters Data						
Rated Current (A)	0.55/0.60 ± 10%	0.25/0.28 ± 10%	1.22/0.35	0.55/0.60 ± 10%	0.25/0.28 ± 10%	1.22/0.35
Weight (gr/lb)	1600/3.53			1600/3.53		
Noise Level (dB(A))	46/58		59	46/58		59
Durability (hrs at 25 °C)	50,000	50,000	50,000	50,000	50,000	50,000
Operating Temperature (°C/°F)	-20 to +70 / -4 to +158			-20 to +70 / -4 to +158		
Dimensions	10.24" X 10.24" X 4.90" / 260X260X124.5 mm <sup>3</sup>			10.24" X 10.24" X 4.90" / 260X260X124.5 mm <sup>3</sup>		
Certificates	CSA-UL-CE			CSA-UL-CE		
Exhaust Filter-Colors	Type 12-IP 54			Type 3R-IP55		
RAL 7035 Light Gray	FTEC26L4X			FTEC26L5(**)		
RAL 7032 Dark Gray	FTEC26D4X			FTEC26D5(**)		
RAL 9011 Black	FTEC26B4X			FTEC26B5(**)		
Dimensions	10.24" X 10.24" X 1.22" / 260 X 260 X 31 mm <sup>3</sup>			10.24" X 10.24" X 1.22" / 260 X 260 X 31 mm <sup>3</sup>		
Weight (gr/lb)	450/1			450/1		
Certificates	CSA-UL-CE			CSA-UL-CE		
Accessories						
Replacement Filter Media	FTEC26-FM-4			FTEC26-FM-5		
NO Thermostat (°C)	TTEC-200-C	-	-	TTEC-200-C	-	-
NO Thermostat (°F)	TTEC-200-F	-	-	TTEC-200-F	-	-

(\*) 12 means 12 VDC, 24 means 24 VDC, and 48 means 48 VDC

(\*\*) X represents Type 12, IP 54 or IP 55, Z represents Type 3R IP 55

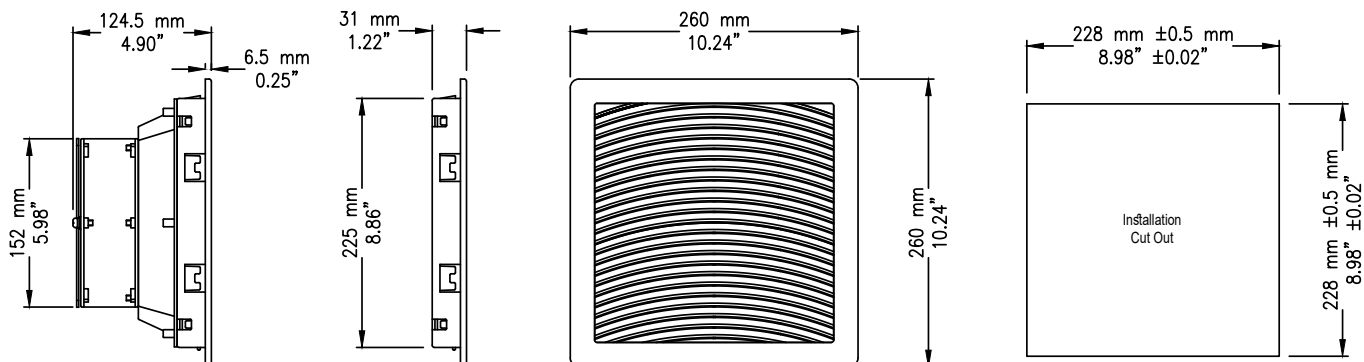
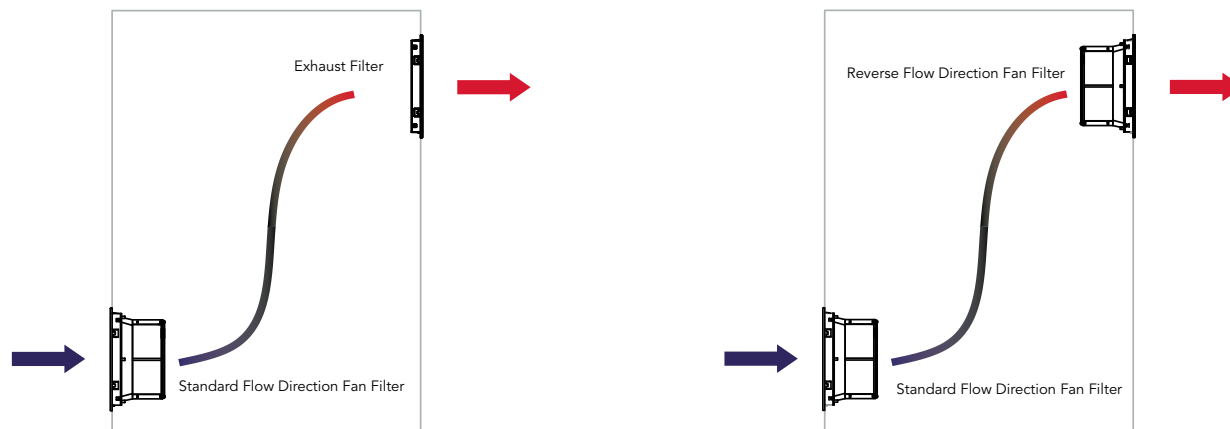

**FTEC26L4X-115SB/FTEC26L4X-230SB**

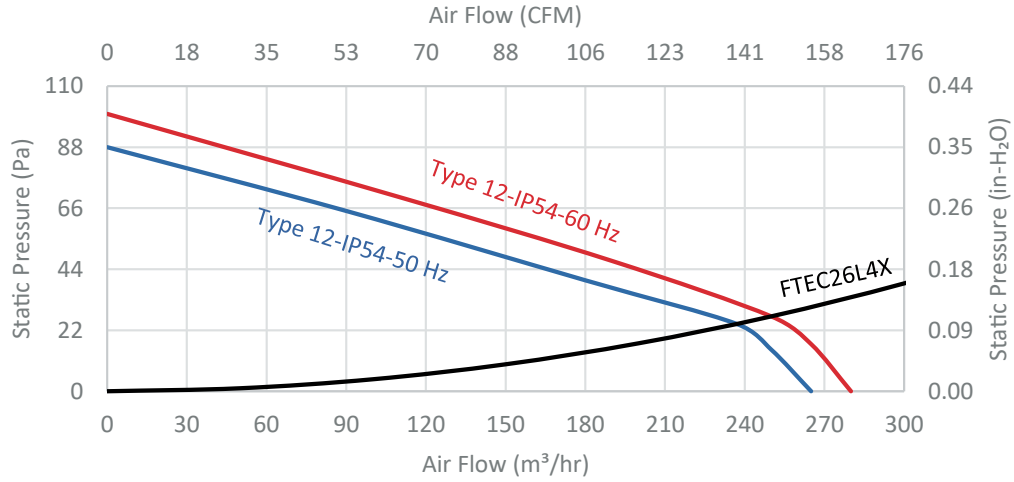

**FTEC26L5(\*\*)-115SB/FTEC26L5(\*\*)-230SB**

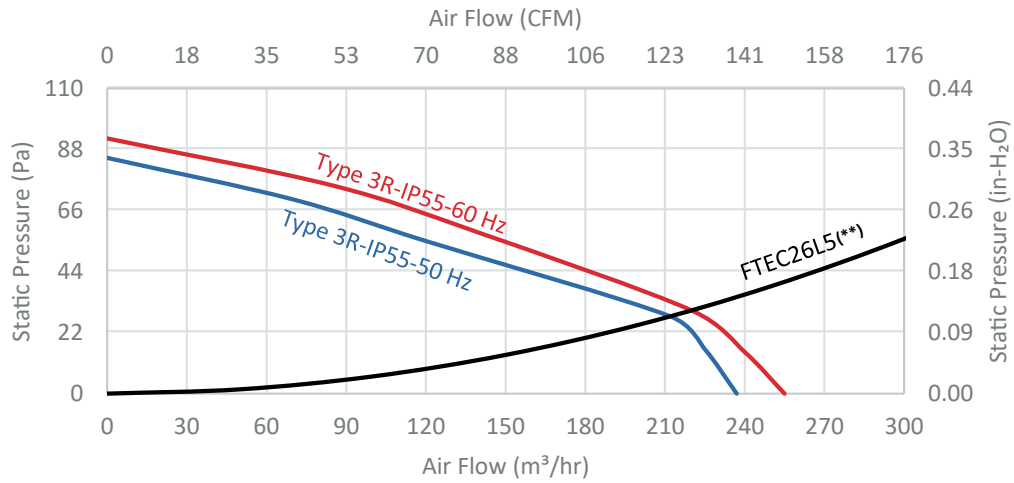

**FTEC26L4X-48DSB/FTEC26L5(\*\*)-48DSB**

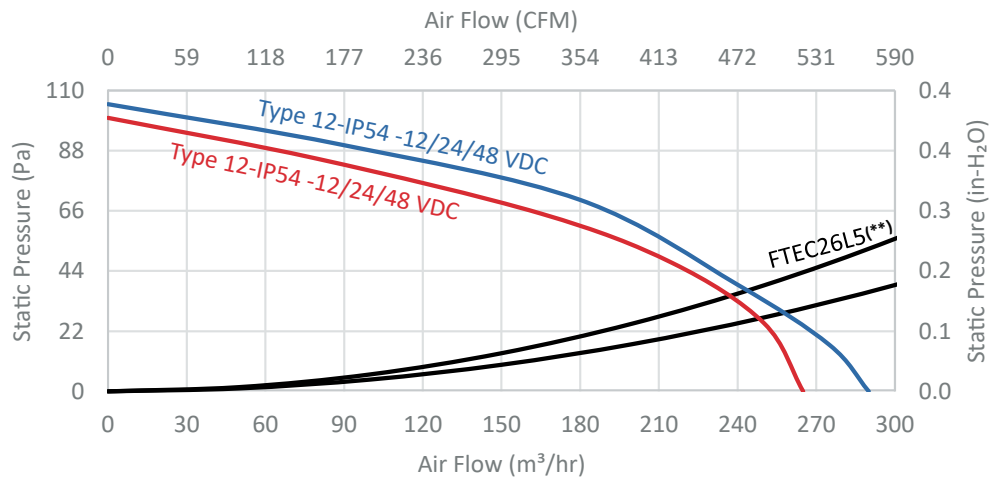

# FTEC 26B SERIES

FTEC26B series Performance Chart - 10" Fan Filter and Exhaust Filter

NEMA Rating	Type 12			Type 3R		
	IP 54			IP 55		
Filter Media	G3					
Rated Voltage	115 VAC	230 VAC	12/24/48 VDC	115 VAC	230 VAC	12/24/48 VDC
Frequency	60/50 Hz	60/50 Hz		60/50 Hz	60/50 Hz	
Bearing	Ball Bearing	Ball Bearing	Ball Bearing	Ball Bearing	Ball Bearing	Ball Bearing
Power connection	2 Poles Terminal & Ground			2 Poles Terminal & Ground		
Fan Filters Colors						
RAL 7035 Light Gray	FTEC26L4X-115SBB	FTEC26L4X-230SBB	FTEC26L4X-(*)DSBB	FTEC26L5(**)-115SBB	FTEC26L5(**)-230SBB	FTEC26L5Z-(*)DSB
RAL 7032 Dark Gray	FTEC26D4X-115SBB	FTEC26D4X-230SBB	FTEC26D4X-(*)DSBB	FTEC26D5(**)-115SBB	FTEC26D5(**)-230SBB	FTEC26D5Z-(*)DSB
RAL 9011 Black	FTEC26B4X-115SBB	FTEC26B4X-230SBB	FTEC26B4X-(*)DSBB	FTEC26B5(**)-115SBB	FTEC26B5(**)-230SBB	FTEC26B5Z-(*)DSB
Flow Capacity (CFM-m <sup>3</sup> /hr at 60/50 Hz) and Maximum Static Pressure (in H <sub>2</sub> O-Pa at 60/50 Hz)						
Unimpeded	230/200-390/340	230/200-390/340	170-290	190/170-325/290	190/170-325/290	155-265
In combination						
Fan Filter+Exhaust Filter	182/159-310/270	182/159-310/270	150-255	153/135-260/230	153/135-260/230	137-230
Max. Static Pressure	0.48/0.41-120/102	0.48/0.41-120/102	0.42/105	0.46/0.39-114/96	0.46/0.39-114/96	0.40-100
Fan Filter+Reverse Flow Fan Filter	210/180-356/306	210/180-356/306	160-270	172/155-292/263	172/155-292/263	147-250
Max. Static Pressure	0.55/0.46-137/114	0.55/0.46-137/114	0.48-120	0.53/0.45-132/112	0.53/0.45-132/112	0.44-110
Other Fan Filters Data						
Rated Current (A)	0.55/0.60 ± 10%	0.25/0.28 ± 10%	1.22/0.35	0.55/0.60 ± 10%	0.25/0.28 ± 10%	1.22/0.35
Weight (gr/lb)	1650/3.64			1650/3.64		
Noise Level (dB(A))	65/60			65/60		
Durability (hrs at 25 °C)	50,000	50,000	50,000	50,000	50,000	50,000
Operating Temperature (°C/°F)	-20 to +70 / -4 to +158			-20 to +70 / -4 to +158		
Dimensions	10.24" X 10.24" X 4.90" / 260X260X124.5 mm <sup>3</sup>			10.24" X 10.24" X 4.90" / 260X260X124.5 mm <sup>3</sup>		
Certificates	CSA-UL-CE			CSA-UL-CE		
Exhaust Filter-Colors	Type 12 -IP 54			Type 3R -IP55		
RAL 7035 Light Gray	FTEC26L4X			FTEC26L5(**)		
RAL 7032 Dark Gray	FTEC26D4X			FTEC26D5(**)		
RAL 9011 Black	FTEC26B4X			FTEC26B5(**)		
Dimensions	10.24" X 10.24" X 1.22" / 260 X 260 X 31 mm <sup>3</sup>			10.24" X 10.24" X 1.22" / 260 X 260 X 31 mm <sup>3</sup>		
Weight (gr/lb)	450/1			450/1		
Certificates	CSA-UL-CE			CSA-UL-CE		
Accessories						
Replacement Filter Media	FTEC26-FM-4			FTEC26-FM-5		
NO Thermostat (°C)	TTEC-200-C	-	-	TTEC-200-C	-	-
NO Thermostat (°F)	TTEC-200-F	-	-	TTEC-200-F	-	-

(\* ) 12 means 12 VDC, 24 means 24 VDC, and 48 means 48 VDC

(\*\*) X represents Type 12, IP 54 or IP 55, Z represents Type 3R IP 55

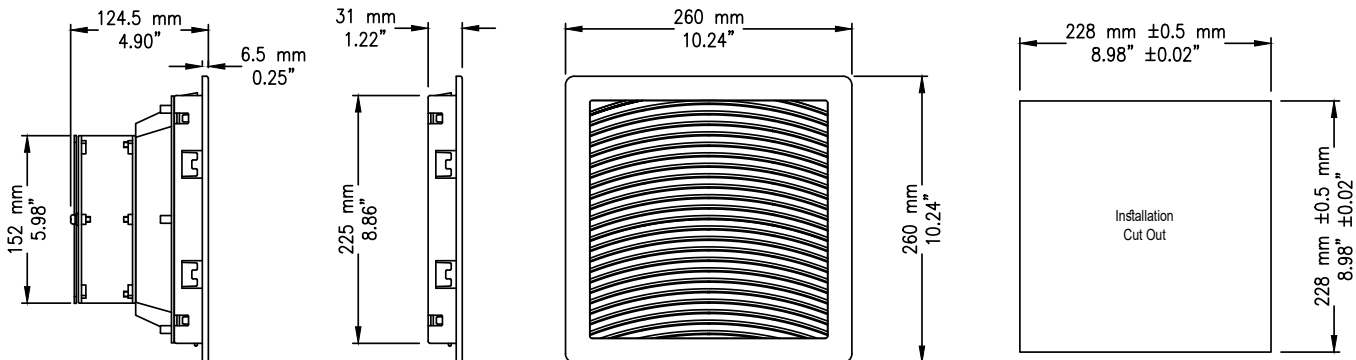
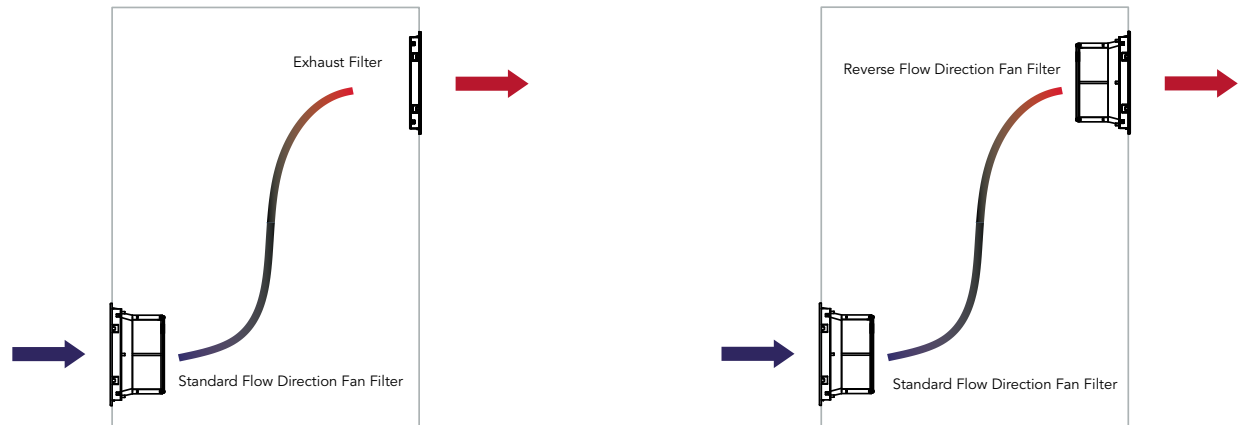



**FTEC26L4X-115SBB/FTEC26L4X-230SBB**

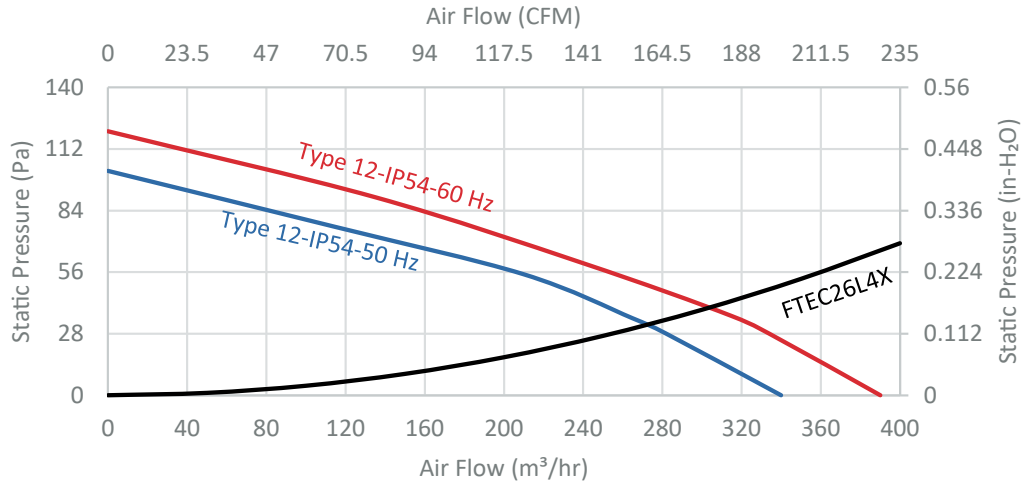

**FTEC26L5(\*\*) -115SBB/FTEC26L5(\*\*) - 230SBB**

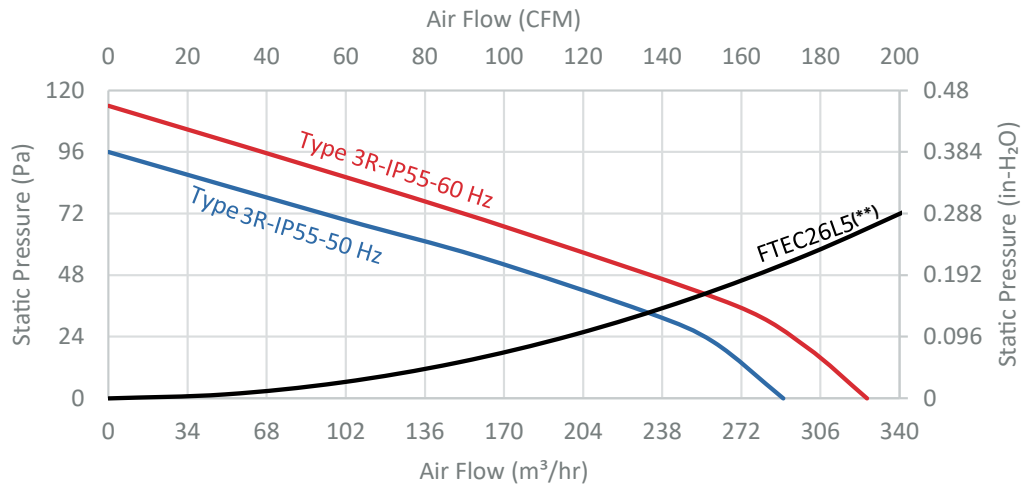

**FTEC26L4X-48DSB/FTEC26L5(\*\*)-48DSB**

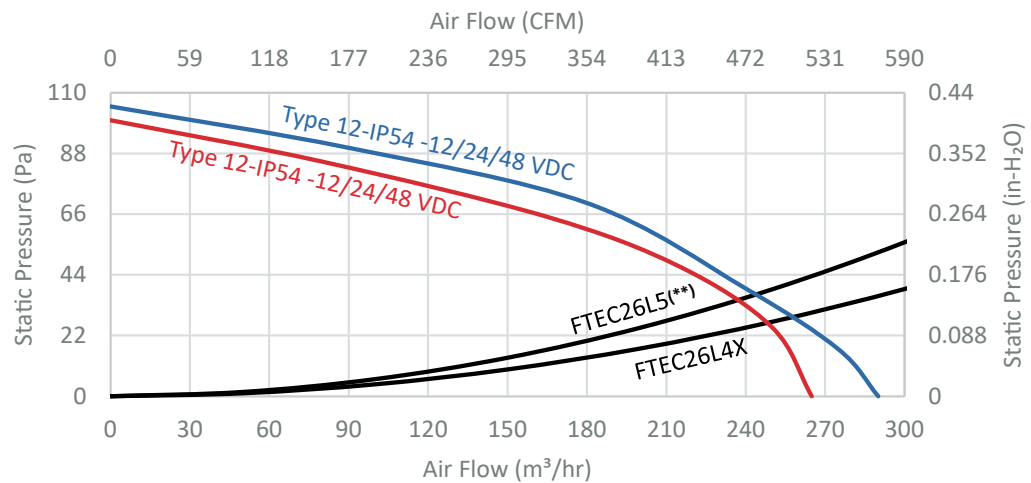

# FTEC 32 SERIES

FTEC32 series Performance Chart - 12" Fan Filter and Exhaust Filter

NEMA Rating	Type 12			Type 3R		
	IP 54			IP 55		
Filter Media	G3			G4		
Rated Voltage	115 VAC	230 VAC	12/24/48 VDC	115 VAC	230 VAC	12/24/48 VDC
Frequency	60/50 Hz	60/50 Hz		60/50 Hz	60/50 Hz	
Bearing	Ball Bearing	Ball Bearing	Ball Bearing	Ball Bearing	Ball Bearing	Ball Bearing
Power connection	2 Poles Terminal & Ground		Wires	2 Poles Terminal & Ground		Wires
Fan Filters Colors						
RAL 7035 Light Gray	FTEC32L4X-115SB	FTEC32L4X-230SB	FTEC32L4X- (*)DSB	FTEC32L5(**)-115SB	FTEC32L5(**)-230SB	FTEC32L5(**)- (*)DSB
RAL 7032 Dark Gray	FTEC32D4X-115SB	FTEC32D4X-230SB	FTEC32D4X- (*)DSB	FTEC32D5(**)-115SB	FTEC32D5(**)-230SB	FTEC32D5(**)- (*)DSB
RAL 9011 Black	FTEC32B4X-115SB	FTEC32B4X-230SB	FTEC32B4X- (*)DSB	FTEC32B5(**)-115SB	FTEC32B5(**)-230SB	FTEC32B5(**)- (*)DSB
Flow Capacity (CFM-m <sup>3</sup> /hr at 60/50 Hz) and Maximum Static Pressure (in H <sub>2</sub> O-Pa at 60/50 Hz)						
Unimpeded	380/360-645/610	380/360-645/610	550-935	350/335-595/570	350/335-595/570	500-850
In combination						
Fan Filter+Exhaust Filter	220/210-375/355	220/210-375/355	330-560	190/180-320/305	190/180-320/305	280-475
Max. Static Pressure	0.44/0.40-110/100	0.44/0.40-110/100	0.60/150	0.42/0.40-105/100	0.42/0.40-105/100	0.54-135
Fan Filter+Reverse Flow Fan Filter	320/300-545/510	320/300-545/510	450-765	270/255-460/435	270/255-460/435	400-680
Max. Static Pressure	0.50/0.48-125/120	0.50/0.48-125/120	0.72-180	0.47/0.44-118/110	0.47/0.44-118/110	0.62-155
Other Fan Filters Data						
Rated Current (A)	0.30/0.32 ± 10%	0.14/0.13 ±10%	1.4	0.30/0.32 ± 10%	0.14/0.13 ±10%	1.4
Weight (gr/lb)	3000/6.6			3000/6.6		
Noise Level (dB(A))	48/50		60	47/49		60
Durability (hrs at 25 °C)	50,000	50,000	50,000	50,000	50,000	50,000
Operating Temperature (°C/°F)	-20 to +70 / -4 to +158			-20 to +70 / -4 to +158		
Dimensions	12.84" X 12.84" X 6.38" / 326 X 326 X 162 mm <sup>3</sup>			12.84" X 12.84" X 6.38" / 326 X 326 X 162 mm <sup>3</sup>		
Certificates	CSA-UL-CE			CSA-UL-CE		
Exhaust Filter-Colors	Type 12-IP 54			Type 3R-IP55		
RAL 7035 Light Gray	FTEC32L4X			FTEC32L5(**)		
RAL 7032 Dark Gray	FTEC32D4X			FTEC32D5(**)		
RAL 9011 Black	FTEC32B4X			FTEC32B5(**)		
Dimensions	12.84" X 12.84" X 1.22" / 326 X 326 X 31 mm <sup>3</sup>			12.84" X 12.84" X 1.22" / 326 X 326 X 31 mm <sup>3</sup>		
Weight (gr/lb)	750/1.65			750/1.65		
Certificates	CSA-UL-CE			CSA-UL-CE		
Accessories						
Replacement Filter Media	FTEC32-FM-4			FTEC32-FM-5		
NO Thermostat (°C)	TTEC-200-C	-	-	TTEC-200-C	-	-
NO Thermostat (°F)	TTEC-200-F	-	-	TTEC-200-F	-	-

(\*) 12 means 12 VDC, 24 means 24 VDC, and 48 means 48 VDC

(\*\*) X represents Type 12, IP 54 or IP 55, Z represents Type 3R IP 55

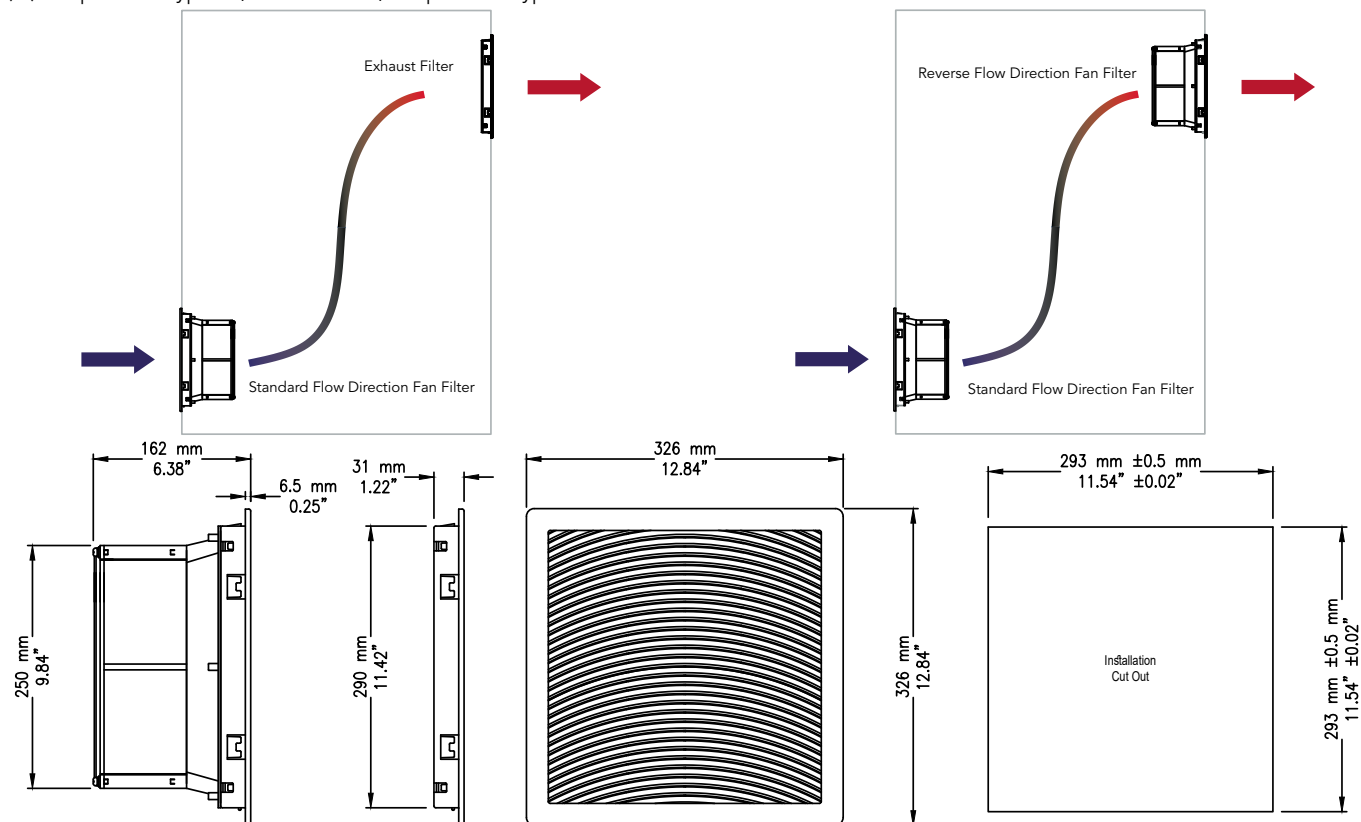

**FTEC32L4X-115SB/FTEC32L4X-230SB**

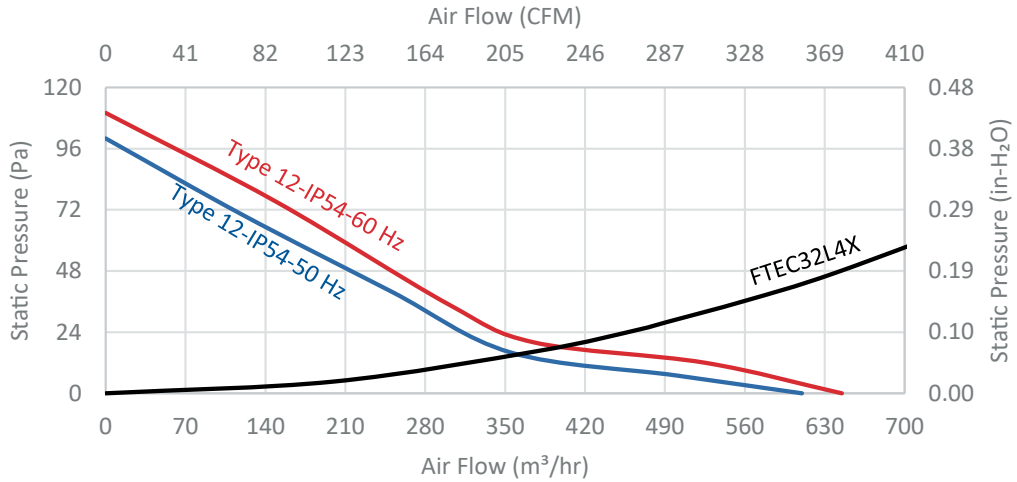

**FTEC32L5(\*\*)-115SB/FTEC32L5(\*\*)-230SB**

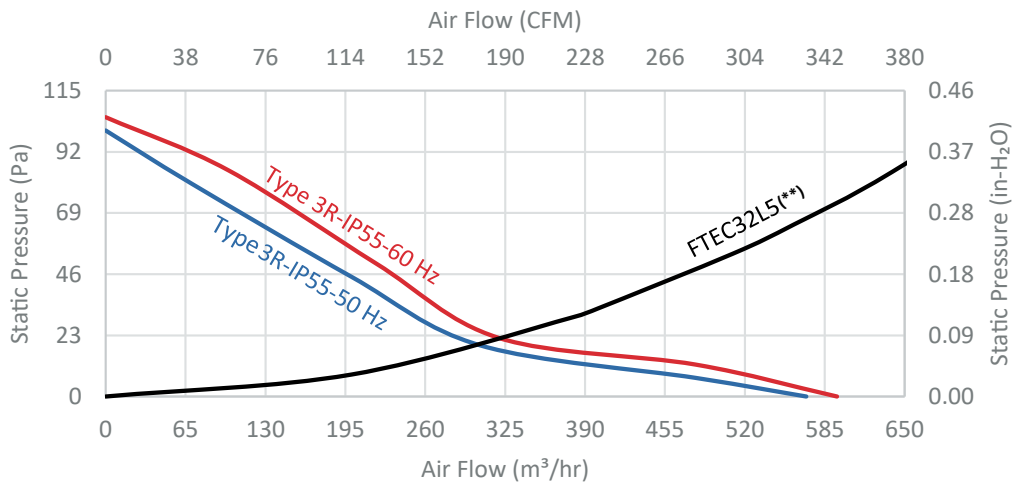

**FTEC32L4X-48DSB/FTEC32L5(\*\*)-48DSB**

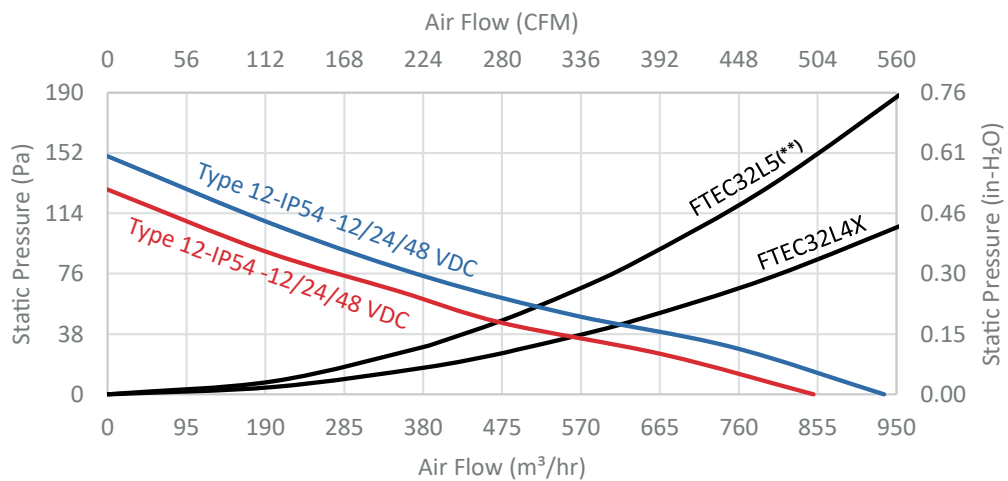

# FTEC 32B SERIES

FTEC32B series Performance Chart - 12" Fan Filter and Exhaust Filter

NEMA Rating	Type 12			Type 3R		
	IP 54			IP 55		
Filter Media	G3			G4		
Rated Voltage	115 VAC	230 VAC	12/24/48 VDC	115 VAC	230 VAC	12/24/48 VDC
Frequency	60/50 Hz	60/50 Hz		60/50 Hz	60/50 Hz	
Bearing	Ball Bearing	Ball Bearing	Ball Bearing	Ball Bearing	Ball Bearing	Ball Bearing
Power connection	2 Poles Terminal & Ground		Wires	2 Poles Terminal & Ground		Wires
Fan Filters Colors						
RAL 7035 Light Gray	FTEC32L4X-115SBB	FTEC32L4X-230SBB	FTEC32L4X-(*)DSB	FTEC32L5(**)-115SBB	FTEC32L5(**)-230SBB	FTEC32L5(**)-(*)DSB
RAL 7032 Dark Gray	FTEC32D4X-115SBB	FTEC32D4X-230SBB	FTEC32D4X-(*)DSB	FTEC32D5(**)-115SBB	FTEC32D5(**)-230SBB	FTEC32D5(**)-(*)DSB
RAL 9011 Black	FTEC32B4X-115SBB	FTEC32B4X-230SBB	FTEC32B4X-(*)DSB	FTEC32B5(**)-115SBB	FTEC32B5(**)-230SBB	FTEC32B5(**)-(*)DSB
Flow Capacity (CFM-m <sup>3</sup> /hr at 60/50 Hz) and Maximum Static Pressure (in H <sub>2</sub> O-Pa at 60/50 Hz)						
Unimpeded	450/425-765/722	450/425-765/722	550-935	418/396-712/675	418/396-712/675	500-850
In combination						
Fan Filter+Exhaust Filter	290/275-492/467	290/275-492/467	330-560	235/225-400/380	235/225-400/380	280-475
Max. Static Pressure	0.50/0.46-125/115	0.50/0.46-125/115	0.60/150	0.48/0.44-120/110	0.48/0.44-120/110	0.54-135
Fan Filter+Reverse Flow Fan Filter	425/400-722/680	425/400-722/680	450-765	385/365-655/622	385/365-655/622	400-680
Max. Static Pressure	0.56/0.51-140/128	0.56/0.51-140/128	0.72-180	0.53/0.50-132/125	0.53/0.50-132/125	0.62-155
Other Fan Filters Data						
Rated Current (A)	0.673/0.579 ± 10%	0.296/0.259 ± 10%	1.4	0.673/0.579 ± 10%	0.296/0.259 ± 10%	1.4
Weight (gr/lb)	3450/7.6			3450/7.7		
Noise Level (dB(A))	58/61		60	56/59		60
Durability (hrs at 25 °C)	50,000	50,000	50,000	50,000	50,000	50,000
Operating Temperature (°C/°F)	-20 to +70 / -4 to +158			-20 to +70 / -4 to +158		
Dimensions	12.84" X 12.84" X 6.38" / 326 X 326 X 162 mm <sup>3</sup>			12.84" X 12.84" X 6.38" / 326 X 326 X 162 mm <sup>3</sup>		
Certificates	CSA-UL-CE			CSA-UL-CE		
Exhaust Filter-Colors	Type 12-IP 54			Type 3R-IP55		
RAL 7035 Light Gray	FTEC32L4X			FTEC32L5(**)		
RAL 7032 Dark Gray	FTEC32D4X			FTEC32D5(**)		
RAL 9011 Black	FTEC32B4X			FTEC32B5(**)		
Dimensions	12.84" X 12.84" X 1.22" / 326 X 326 X 31 mm <sup>3</sup>			12.84" X 12.84" X 1.22" / 326 X 326 X 31 mm <sup>3</sup>		
Weight (gr/lb)	750/1.65			750/1.65		
Certificates	CSA-UL-CE			CSA-UL-CE		
Accessories						
Replacement Filter Media	FTEC32-FM-4			FTEC32-FM-5		
NO Thermostat (°C)	TTEC-200-C		-	TTEC-200-C		-
NO Thermostat (°F)	TTEC-200-F		-	TTEC-200-F		-

(\*) 12 means 12 VDC, 24 means 24 VDC, and 48 means 48 VDC

(\*\*) X represents Type 12, IP 54 or IP 55, Z represents Type 3R IP 55

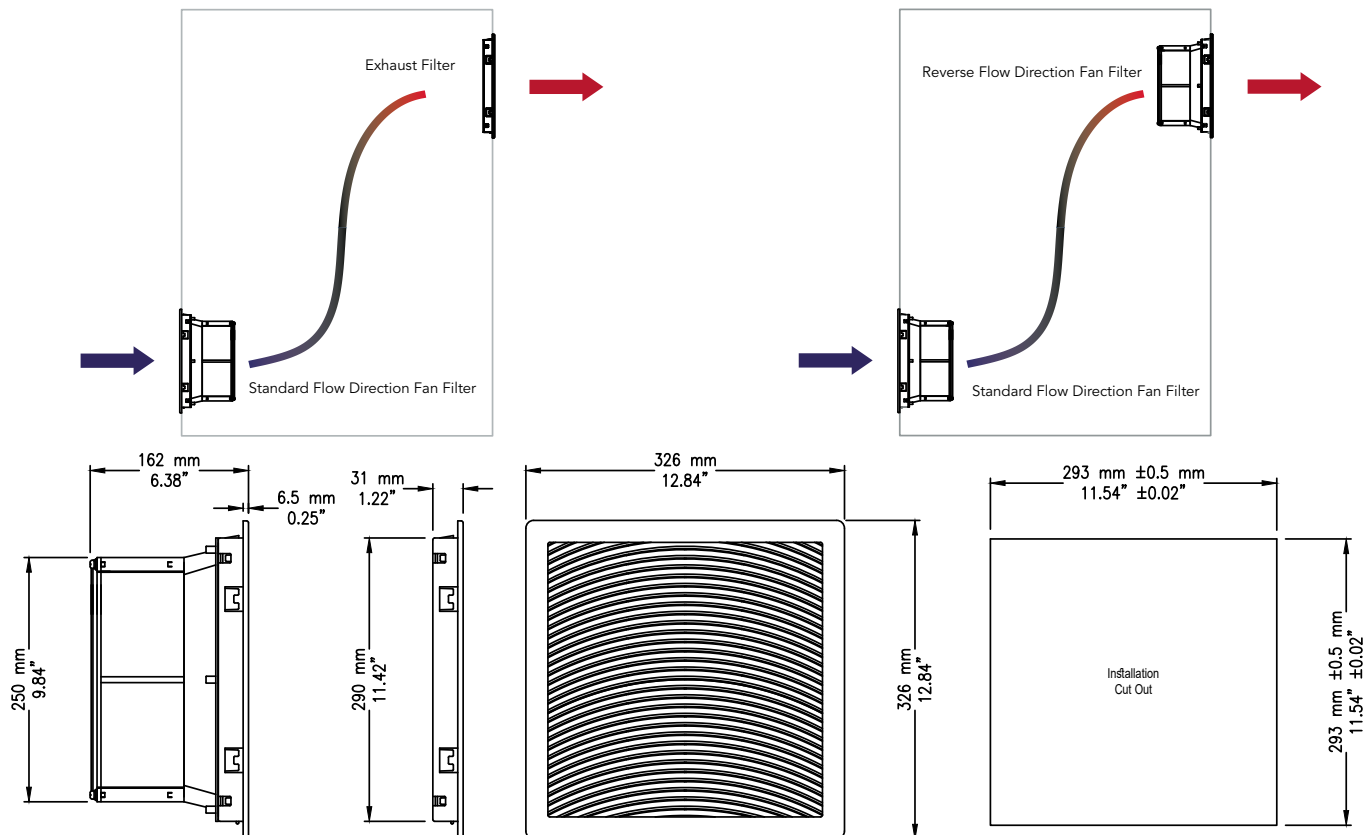

**FTEC32L4X-115SBB/FTEC32L4X-230SBB**

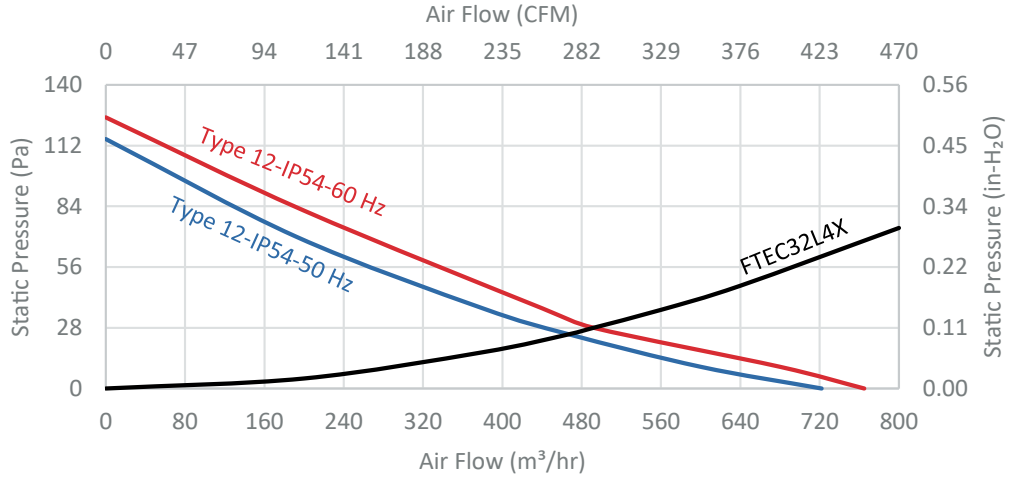

**FTEC32L5(\*\*)-115SBB/FTEC32L5(\*\*)-230SBB**

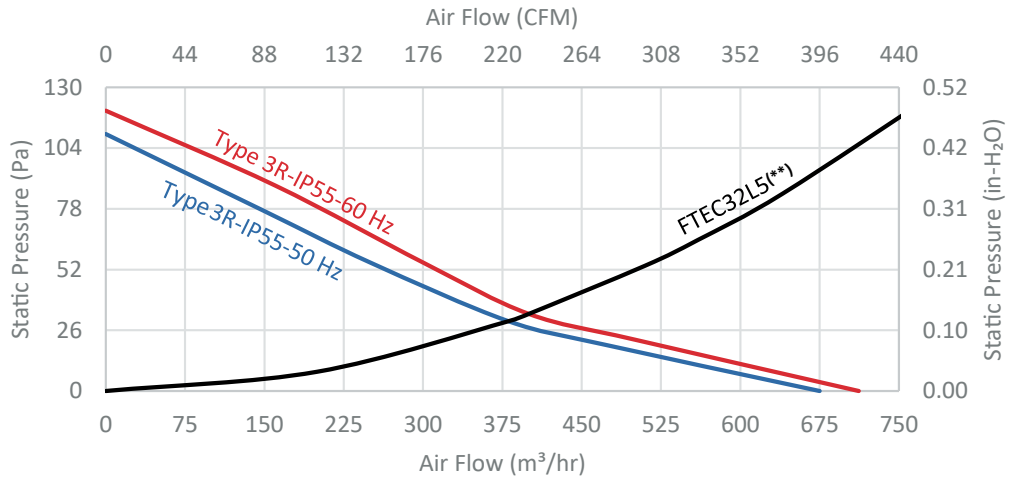

**FTEC32L4X-48DSB/FTEC32L5(\*\*)-48DSB**

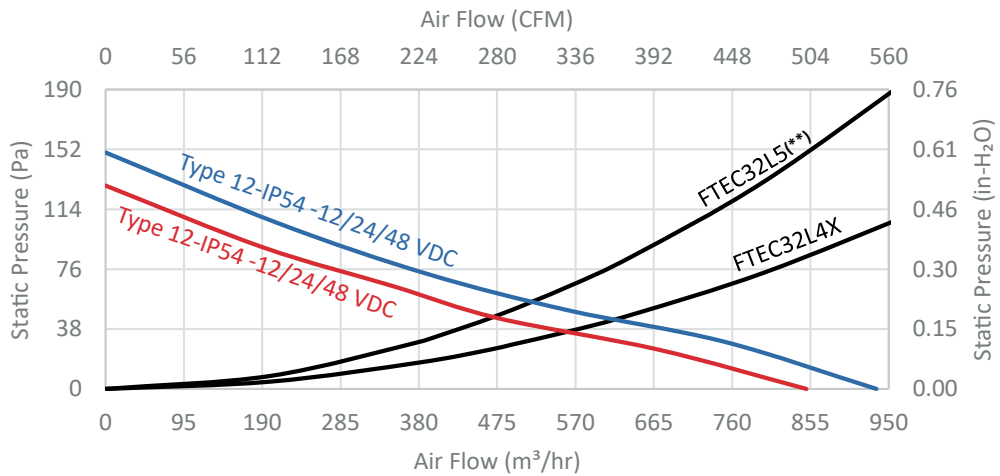

# FTEC 32G SERIES

FTEC32G series Performance Chart - 12" Fan Filter and Exhaust Filter

NEMA Rating	Type 12			Type 3R		
	IP 54			IP 55		
Filter Media	G3					
Rated Voltage	115 VAC	230/460 VAC	12/24/48 VDC	115 VAC	230/460 VAC	12/24/48 VDC
Frequency	60/50 Hz	60/50 Hz		60/50 Hz	60/50 Hz	
Bearing	Ball Bearing	Ball Bearing	Ball Bearing	Ball Bearing	Ball Bearing	Ball Bearing
Power connection	2 Poles Terminal & Ground		Wires	2 Poles Terminal & Ground		Wires
Fan Filters Colors						
RAL 7035 Light Gray	FTEC32L4X-115SBG	FTEC32L4X-(***)SBG	FTEC32L4X-(*)DSB	FTEC32L5(**)-115SBG	FTEC32L5(**)-230SBG	FTEC32L5(**)-(*)DSB
RAL 7032 Dark Gray	FTEC32D4X-115SBG	FTEC32D4X-(***)SBG	FTEC32D4X-(*)DSB	FTEC32D5(**)-115SBG	FTEC32D5(**)-230SBG	FTEC32D5(**)-(*)DSB
RAL 9011 Black	FTEC32B4X-115SBG	FTEC32B4X-(***)SBG	FTEC32B4X-(*)DSB	FTEC32B5(**)-115SBG	FTEC32B5(**)-230SBG	FTEC32B5(**)-(*)DSB
Flow Capacity (CFM-m <sup>3</sup> /hr at 60/50 Hz) and Maximum Static Pressure (in H <sub>2</sub> O-Pa at 60/50 Hz)						
Unimpeded	625/595-1060/1010	625/595-1060/1010	550-935	595/565-1010/960	595/565-1010/960	500-850
In combination						
Fan Filter+Exhaust Filter	430/410-730/695	430/410-730/695	330-560	420/400-715/680	420/400-715/680	280-475
Max. Static Pressure	0.82/0.77-205/192	0.82/0.77-205/192	0.60/150	0.80/0.76-198/188	0.80/0.76-198/188	0.54-135
Fan Filter+Reverse Flow Fan Filter	570/540-968/917	570/540-968/917	450-765	530/510-900/866	530/510-900/866	400-680
Max. Static Pressure	0.88/0.84-220/210	0.56/0.51-140/128	0.72-180	0.84/0.81-210/202	0.84/0.81-210/202	0.62-155
Other Fan Filters Data						
Rated Current (A)	0.913/0.826 ± 10%	0.456/0.413 ± 10%	1.4	0.913/0.826 ± 10%	0.456/0.413 ± 10%	1.4
Weight (gr/lb)	3,700/8.16			3,700/8.16		
Noise Level (dB(A))	68/70		60	68/70		60
Durability (hrs at 25 °C)	50,000	50,000	50,000	50,000	50,000	50,000
Operating Temperature (°C/°F)	-20 to +70 / -4 to +158			-20 to +70 / -4 to +158		
Dimensions	12.84" X 12.84" X 6.38" / 326 X 326 X 162 mm <sup>3</sup>			12.84" X 12.84" X 6.38" / 326 X 326 X 162 mm <sup>3</sup>		
Certificates	CSA and UL Pending-CE			CSA and UL Pending-CE		
Exhaust Filter-Colors	Type 12-IP 54			Type 3R-IP55		
RAL 7035 Light Gray	FTEC32L4X			FTEC32L5(**)		
RAL 7032 Dark Gray	FTEC32D4X			FTEC32D5(**)		
RAL 9011 Black	FTEC32B4X			FTEC32B5(**)		
Dimensions	12.84" X 12.84" X 1.22" / 326 X 326 X 31 mm <sup>3</sup>			12.84" X 12.84" X 1.22" / 326 X 326 X 31 mm <sup>3</sup>		
Weight (gr/lb)	750/1.65			750/1.65		
Certificates	CSA-UL-CE			CSA-UL-CE		
Accessories						
Replacement Filter Media	FTEC32-FM-4			FTEC32-FM-5		
NO Thermostat (°C)	TTEC-200-C	-	-	TTEC-200-C	-	-
NO Thermostat (°F)	TTEC-200-F	-	-	TTEC-200-F	-	-

(\*) 12 means 12 VDC, 24 means 24 VDC, and 48 means 48 VDC  
 (\*\*) X represents Type 12, IP 54 or IP 55 and Z represents Type 3R, IP 55  
 (\*\*\*) 230 represents 230 VAC, and 440 VAC represents 460VAC

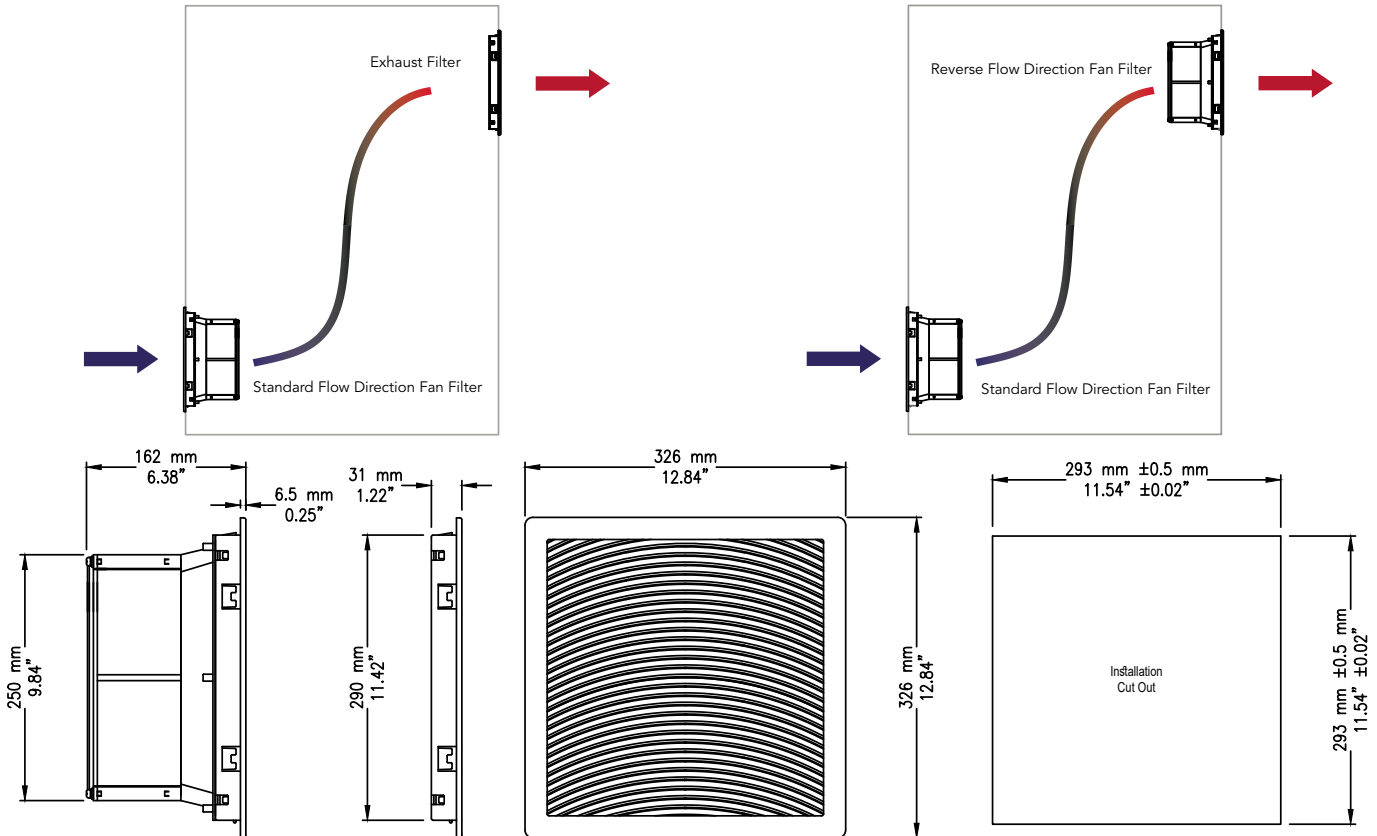

**FTEC32L4X-115SBG/FTEC32L4X-230SBG/FTEC32L4X-440SBG**

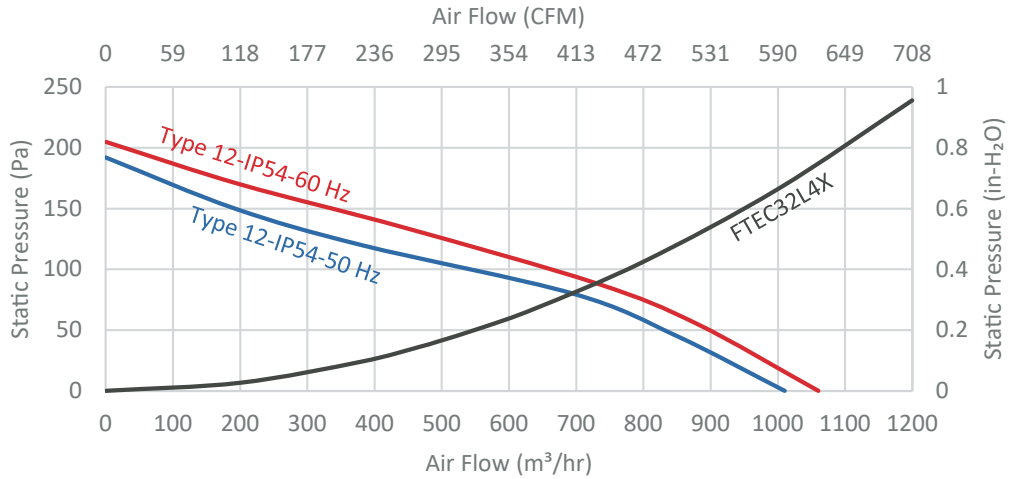

**FTEC32L5(\*\*)-115SBG/FTEC32L5(\*\*)-230SBG-FTEC32L5(\*\*)-440SBG**

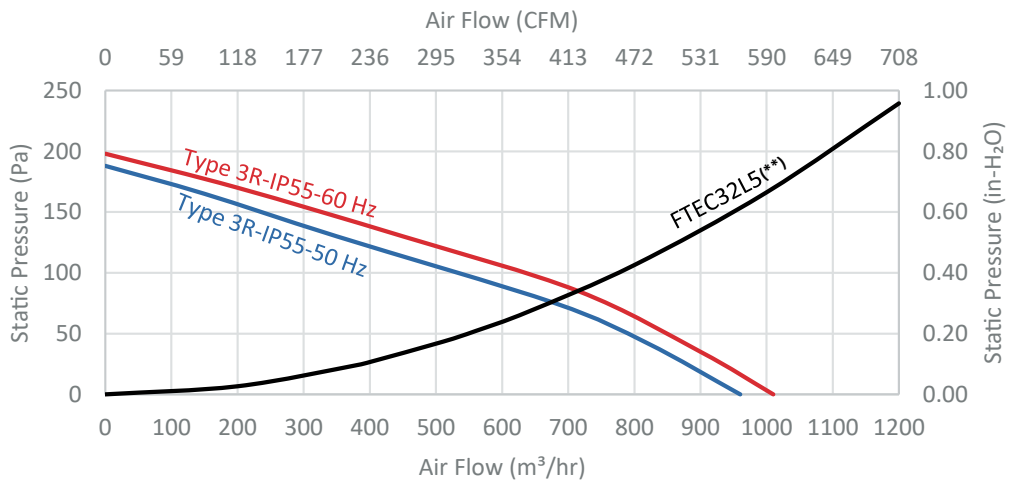

**FTEC32L4X-48DSB/FTEC32L5(\*\*)-48DSB**

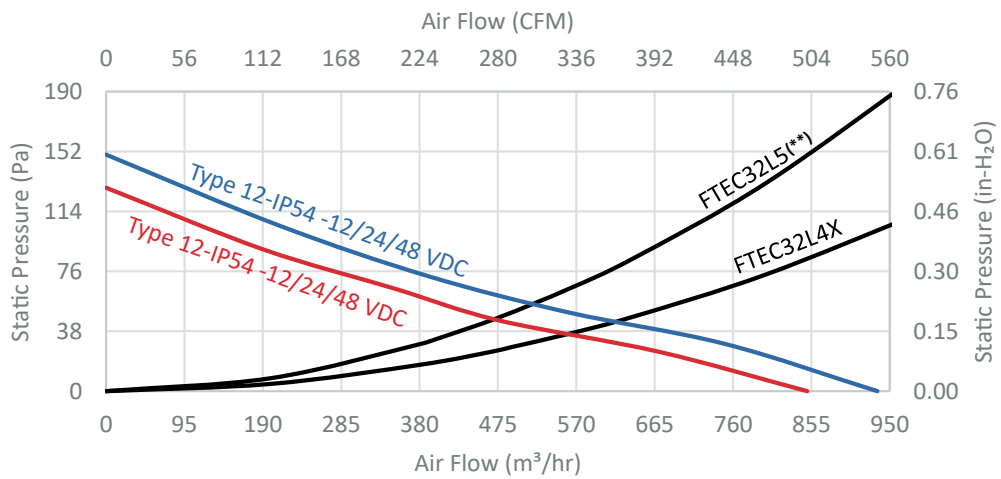

# FAN

## FANTEC Series

FANTEC

### Certificates

- UL and cUL Recognized, File Number E508880
- CE Compliant

### Application

FANTEC series Axial Fans are designed to supply forced convection air to enclosures and electrical panels. By using the unique cooling features, FANTECs will cool down the inside of enclosures to a desired temperature to protect the electrical and electronic parts against heat.

### Features

- Wide range of operating temperatures from -20 C/68 F to 70 C/158 F
- Fans are available in 115, 230 VAC, 460 VAC and 12, 24, and 48 VDC
- Airflow from 24 CFM to 1000 CFM (40 m<sup>3</sup>/hr to 1700 m<sup>3</sup>/hr)
- Thermally or Impedance Protected
- 50,000 hrs life cycle
- Aluminum Die Cast housing

### Color

- Black



UL<sup>®</sup>  
cUL<sup>®</sup> US  
E508880

CE



# TECHNICAL DATA

Model No.	Outline Dimension	Rated Voltage	Frequency	Power Consumption	Rotating Speed	Max. Air Flow	Max. Static Pressure	Noise Level
AR8038115XBT	80 X 80 X 38 mm	115 VAC	50/60 Hz	12/9 W ± 10%	2400/2900 RPM ± 10%	0.68/0.80 m³/min	3.5/4.9 mmH2O	33/38 dB(A)
	3-5/32" X 3-5/32" X 1-1/2"					24/28.4 CFM	0.14/0.19 inchH2O	
AR8038230XBT	80 X 80 X 38 mm	230 VAC	50/60 Hz	17/12 W ± 10%	2400/2900 RPM ± 10%	0.68/0.80 m³/min	3.5/4.9 mmH2O	33/38 dB(A)
	3-5/32" X 3-5/32" X 1-1/2"					24/28.4 CFM	0.14/0.19 inchH2O	
AR803812XBT	80 X 80 X 38 mm	12 VDC	-	10.8 (MAX. 21.6) W	6000 RPM ± 10%	2.28 m³/min	17.77 mmH2O	55 dB(A)
	3-5/32" X 3-5/32" X 1-1/2"					80 CFM	0.69 inchH2O	
AR803824XBT	80 X 80 X 38 mm	24 VDC	-	9.6 (Max. 21.12) W	6000 RPM ± 10%	2.28 m³/min	17.77 mmH2O	55 dB(A)
	3-5/32" X 3-5/32" X 1-1/2"					80 CFM	0.69 inchH2O	
AR803848XBT	80 X 80 X 38 mm	48 VDC	-	9.6 (Max. 24) W	6000 RPM ± 10%	2.28 m³/min	17.77 mmH2O	55 dB(A)
	3-5/32" X 3-5/32" X 1-1/2"					80 CFM	0.69 inchH2O	
AR12038115XBT	120 x 120 x 38 mm	115 VAC	50/60 Hz	20/17 W ± 10%	2650/3000 RPM ± 10%	2.38/2.72 m³/min	7.5/7.8 mmH2O	43/47 dB(A)
	4-23/32" X 4-23/32" X 1-1/2"					84/96 CFM	0.30/31 inchH2O	
AR12038230XBT	120 x 120 x 38 mm	230 VAC	50/60 Hz	17/15 W ± 10%	2650/3000 RPM ± 10%	2.38/2.72 m³/min	7.5/7.8 mmH2O	43/47 dB(A)
	4-23/32" X 4-23/32" X 1-1/2"					84/96 CFM	0.30/31 inchH2O	
AR1203812XBT	120 x 120 x 38 mm	12 VDC	-	16.2 (Max. 18) W	3500 RPM ± 10%	5.24 m³/min	12.23 mmH2O	52 dB(A)
	4-23/32" X 4-23/32" X 1-1/2"					185 CFM	0.48 inchH2O	
AR1203824XBT	120 x 120 x 38 mm	24 VDC	-	20.4 (Max. 34.8) W	3500 RPM ± 10%	5.24 m³/min	12.23 mmH2O	52 dB(A)
	4-23/32" X 4-23/32" X 1-1/2"					185 CFM	0.48 inchH2O	
AR1203848XBT	120 x 120 x 38 mm	48 VDC	-	15.36 (Max. 19.2) W	3500 RPM ± 10%	5.24 m³/min	12.23 mmH2O	52 dB(A)
	4-23/32" X 4-23/32" X 1-1/2"					185 CFM	0.48 inchH2O	
AR17251115XBT	ø 172 X 150 X 51 mm	115 VAC	50/60 Hz	43/40 W ± 10%	2700/3000 RPM ± 10%	4.96/5.10 m³/min	12/7.5 mmH2O	56/58 dB(A)
	6-49/64" X 5-29/32" X 2-1/64"					175/180 CFM	0.47/0.30 inchH2O	
AR17251230XBT	ø 172 X 150 X 51 mm	230 VAC	50/60 Hz	38/36 W ± 10%	2700/3000 RPM ± 10%	4.96/5.10 m³/min	12/7.5 mmH2O	56/58 dB(A)
	6-49/64" X 5-29/32" X 2-1/64"					175/180 CFM	0.47/0.30 inchH2O	
AR17251115XBTM	ø 172 X 150 X 51 mm	115 VAC	50/60 Hz	36/33 W ± 10%	2750/3150 RPM ± 10%	5.9/7.1 m³/min	13.9/14.73 mmH2O	56/58 dB(A)
	6-49/64" X 5-29/32" X 2-1/64"					210/250 CFM	0.47/0.30 inchH2O	
AR17251230XBTM	ø 172 X 150 X 51 mm	230 VAC	50/60 Hz	36/33 W ± 10%	2750/3150 RPM ± 10%	5.9/7.1 m³/min	13.9/14.73 mmH2O	56/58 dB(A)
	6-49/64" X 5-29/32" X 2-1/64"					210/250 CFM	0.47/0.30 inchH2O	
AR1725112XBT	ø 172 X 150 X 51 mm	12 VDC	-	14.64 W ± 10%	3000 RPM ± 10%	6.43 m³/min	10.69 mmH2O	56 dB(A)
	6-49/64" X 5-29/32" X 2-1/64"					185 CFM	0.6 inchH2O	
AR1725148XBT	ø 172 X 150 X 51 mm	48 VDC	-	16.8 W ± 10%	3000 RPM ± 10%	6.43 m³/min	10.69 mmH2O	56 dB(A)
	6-49/64" X 5-29/32" X 2-1/64"					185 CFM	0.6 inchH2O	
AR25089C115XBT	ø 254 X 89 mm	115 VAC	50/60 Hz	30/35 W ± 10%	1500/1650 RPM ± 10%	13/15.5 m³/min	8/10 mmH2O	48/50 dB(A)
	ø 10" X 3-1/2"					460/550 CFM	0.31/0.39 inchH2O	
AR25089C230XBT	ø 254 X 89 mm	230 VAC	50/60 Hz	31/33 W ± 10%	1500/1650 RPM ± 10%	13/15.5 m³/min	8/10 mmH2O	48/50 dB(A)
	ø 10" X 3-1/2"					460/550 CFM	0.31/0.39 inchH2O	
AR25089S115XBT	ø 254 X 89 mm	115 VAC	50/60 Hz	69/79.5 W ± 10%	2100/1800 RPM ± 10%	20.2/17.8 m³/min	8.25/7.15 mmH2O	61/58 dB(A)
	ø 10" X 3-1/2"					700/630 CFM	0.32/0.28 inchH2O	
AR25089S230XBT	ø 254 X 89 mm	230 VAC	50/60 Hz	63.2/72.2 W ± 10%	2100/1800 RPM ± 10%	20.2/17.8 m³/min	8.25/7.15 mmH2O	61/58 dB(A)
	ø 10" X 3-1/2"					700/630 CFM	0.32/0.28 inchH2O	
AR25089G115XBTM	ø 254 X 89 mm	115 VAC	50/60 Hz	95/105 W ± 10%	2800/3250 RPM ± 10%	23.8/28.3 m³/min	19.81/15.24 mmH2O	70/68 dB(A)
	ø 10" X 3-1/2"					840/1000 CFM	0.78/0.60 inchH2O	
AR25089G230XBTM	ø 254 X 89 mm	230 VAC	50/60 Hz	95/105 W ± 10%	2800/3250 RPM ± 10%	23.8/28.3 m³/min	19.81/15.24 mmH2O	70/68 dB(A)
	ø 10" X 3-1/2"					840/1000 CFM	0.78/0.60 inchH2O	
AR25089G440XBTM	ø 254 X 89 mm	440 VAC	50/60 Hz	95/105 W ± 10%	2800/3250 RPM ± 10%	23.8/28.3 m³/min	19.81/15.24 mmH2O	70/68 dB(A)
	ø 10" X 3-1/2"					840/1000 CFM	0.78/0.60 inchH2O	
AR25089S24XBT	ø 254 X 89 mm	24 VDC	-	63 W ± 10%	2500 RPM ± 10%	24.1 m³/min	21.08 mmH2O	68 dB(A)
	ø 10" X 3-1/2"					850 CFM	0.83 inchH2O	
AR2508948XBT	ø 254 X 89 mm	48 VDC	-	67.2 W ± 10%	2500 RPM ± 10%	20.31 m³/min	25.5 mmH2O	68 dB(A)
	ø 10" X 3-1/2"					718 CFM	1.00 inchH2O	

# MECHANICAL THERMOSTATS

Normally Open & Normally Closed

## TTEC

### Certificates

- CSA and CSAus Listed, File Number 80012071
- UL and cUL Recognized, File Number E484831
- CE Compliant

### Application

The TTEC series are thermostat controllers used to regulate the temperature inside industrial control panels or cabinets and control cabinet accessories. The TTEC series control fans, heaters, and switch loads. TTEC-100 and TTEC-200 are identical except the TTEC-100 (Red) is Normally Closed which opens at temperature rise, and turns the Heater off, the TTEC-200 (Blue) is Normally Open which closes at temperature rise, and turns the Fan/Fan Filter on.

### Features

- Controls a wide range of enclosure temperatures from 14 °F to 176 °F (-10 °C to +80 °C)
- Both are available in Fahrenheit or Celsius
- Mechanical NC and NO Thermostats
- Flame retardant housing, UL 94-V0
- Mountable on three different sized DIN Rails (DIN Rail 35 mm, DIN Rail 32 mm, and DIN Rail 15 mm)

### Color

- RAL 7035 - Light Gray



# TECHNICAL SPECIFICATIONS

Type	TTEC -100	TTEC - 200
Function	Normally Closed	Normally Open
Terminal Operated	Between 11 & 12	Between 23 & 24
VDE Rating	250 VAC, 14 A, 50 Hz	
UL Rating	125 VAC, 15 A, 60 Hz	
Setting Temperature	-10 to +80 °C (+14 to 176 °F)	
Design and Test Standard	UL 60730-1	
	UL 60730-2-9	
	UL 60730-2-13	
	CAN/CSA-E60730 - 1:15 CAN/CSA-E60730-2-9:15	
Hi-Pot Test	1800 VAC 0.5 mA, 1 sec	
Mounting	Rail 35 mm according to EN 50022	
	Rail 32 mm according to EN 50035	
	Rail 15 mm according to EN 50045	
Weight	47 gram / 103 lb	
Dimensions	60 mm X 34 mm X 47 mm (2.36" X 1.34" X 1.85")	
Color	RAL 7035-Light Gray	
Electrical Connections	2-Pole for wires section of 12 AWG	
Housing Material	PA 6 UL 94-V0	
Environmental	Indoor	
Hysteresis	Approx. ± 5 °C	
Sensing Element	Bimetal	
Control Type	Operating Control, Type 1	
Rated Impulse Voltage	2500	
Operating temperature	- 20 to +80 °C / -4 to +176 °F	
Shipping and Storage Temperature	- 40 to +80 °C / -40 to +176 °F	

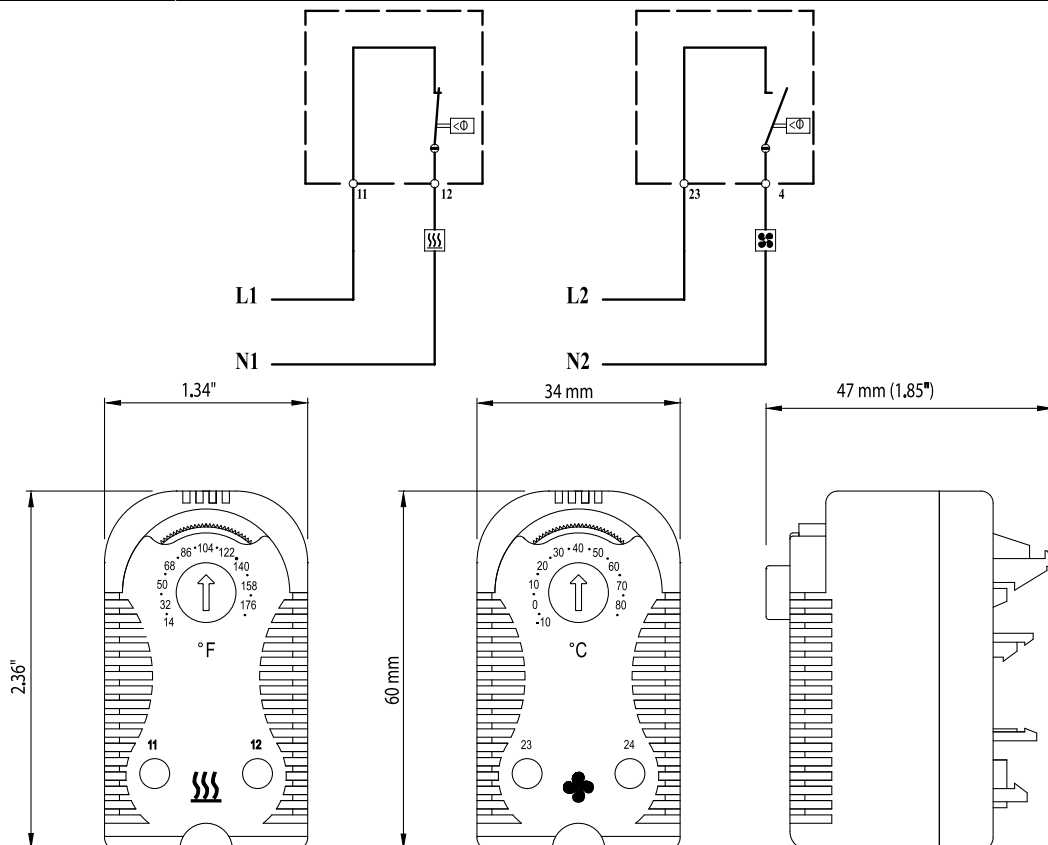

# HUMIDITY CONTROL MECHANICAL HYGROSTAT

## HYTEC

### Certificates

- CSA and CSAus Listed, File Number 80012071
- UL and cUL Recognized, File Number E484831
- CE Compliant

### Application

The HYTEC-100 is designed to control the relative humidity inside of enclosures and electrical panels. The HYTEC-100 starts the heater in order to avoid formation of condensation in enclosures. Designed to protect electronic circuits, preventing the absorption of moisture by electrical and electronic components inside of the enclosure.

### Features

- Controls a wide range of enclosure relative humidity from 10% to 90%
- Can be used for both applications; Humidifiers and Dehumidifiers
- Mechanical Hygrostat
- Mountable on 35 mm DIN Rail
- Flame retardant housing, UL 94-V0

### Color

- RAL 7035 - Light Gray



# TECHNICAL SPECIFICATIONS

Terminal Operated	Between 1 & 2		Between 1 & 3	
Voltage	240 VAC	120 VAC	240 VAC	120 VAC
Full Load	5 A	10 A	2.2 A	4.4 A
Locked Load	22.5 A	45 A	13.2 A	26.5 A
Resistive Load	6 A	12 A	3 A	6 A
Application	Dehumidifier		Humidifier	
	Normally Closed		Normally Open	
	Heater		Fan	
Design and Test Standard	UL 60730-1			
	UL 60730-2-9			
	UL 60730-2-13			
	CAN/CSA-E60730-1:15			
	CAN/CSA-E60730-2-9:15			
Withstanding Voltage	AC 1500 V 1 min or AC 1800 V 1 sec			
Insulation Resistance	Min 100 mΩ at DC 500 V			
Calibration Point	42% RH at room temperature 23 °C ± 2 °C / 74 °F ± 2 °F			
Mounting	Rail 35 mm according to EN 50 022			
Weight	170 gram / 0.375 lb			
Dimensions	101 mm x 57 mm x 55 mm / 3.98" x 2.24" x 2.17"			
Color	RAL 7035			
Electrical Connections	3-Pole screw terminal for wires section of .75/4 mm <sup>2</sup> - AWG 18/12			
Housing Material	PA 6 UL 94-V0			
Environmental	Indoor			
Control Type	Operating Control, Type 1			
Rated Impulse Voltage	2500			
Hysteresis	Approx. 5% RH			
Sensing Element	Synthetic Fiber			
Operating Temperature	10 °C to 40 °C / 50 °F to 104 °F			
Shipping and Storage Temperature	-40 °C to 60 °C / -40 °F to 140 °F			

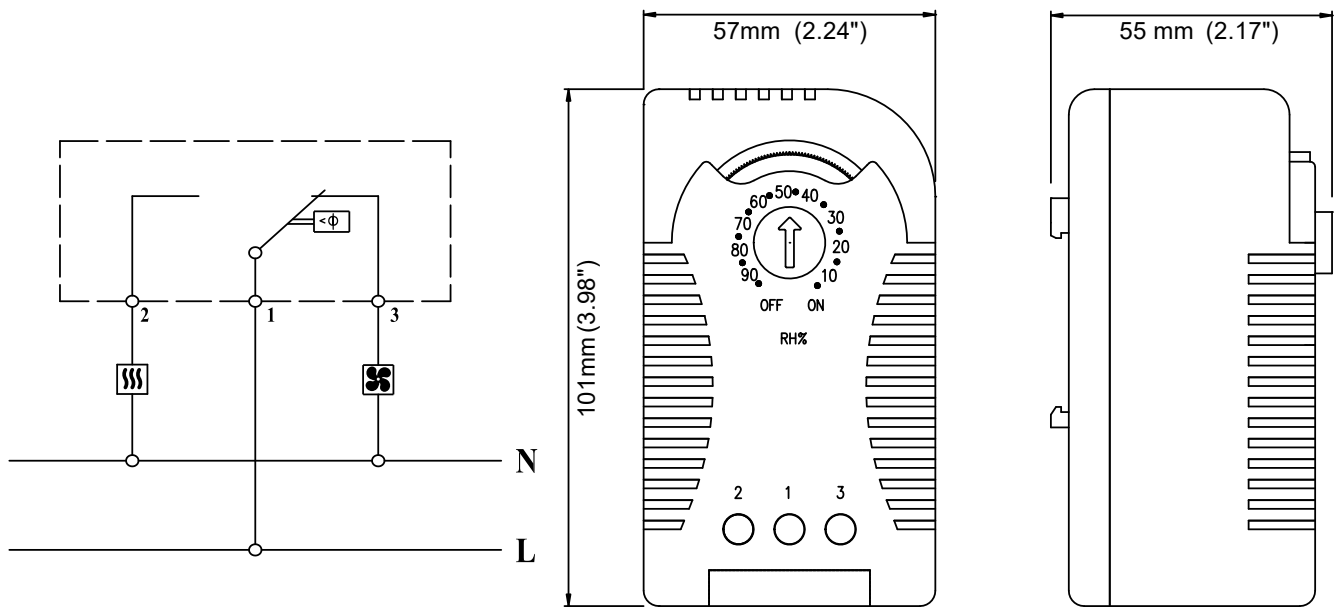

# HEATER

## HEATEC Series

# HEATEC

### Certificates

- UL and cUL Recognized, File Number E515368
- CE Compliant

### Application

Provides protection from condensation and low temperatures in Control Panels, Electronic Enclosures, Hydraulic and Pneumatic machinery

### Features

- Safe, Reliable and consistent heat for long periods by means of PTC (Positive Temperature Coefficient) heater
- Highly efficient and low profile
- Connects easily with push connectors for 3 wires. From AWG 20 to AWG 16 (0.5 - 2.5 mm<sup>2</sup>).
- Built in safety feature prevents overheating
- Used with Normally Closed Thermostat and Hygrostat
- Black anodized aluminum housing
- Mounts easily on 35 mm DIN Rail EN 50 022
- Available in 35 Watt to 150 Watt

### Color

- Black



UL  
E515368

CE

# TECHNICAL SPECIFICATIONS

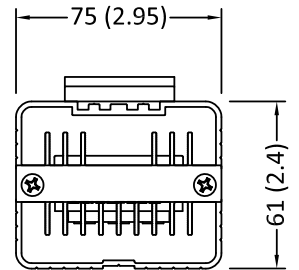
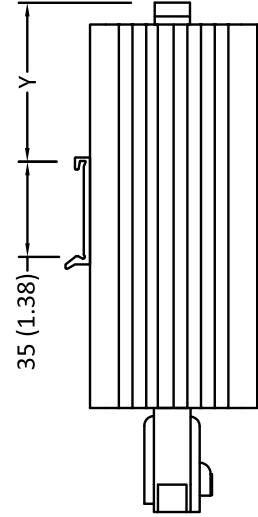
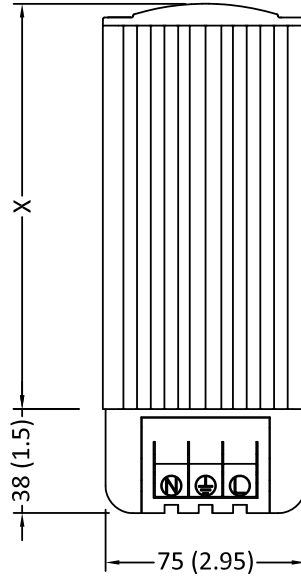
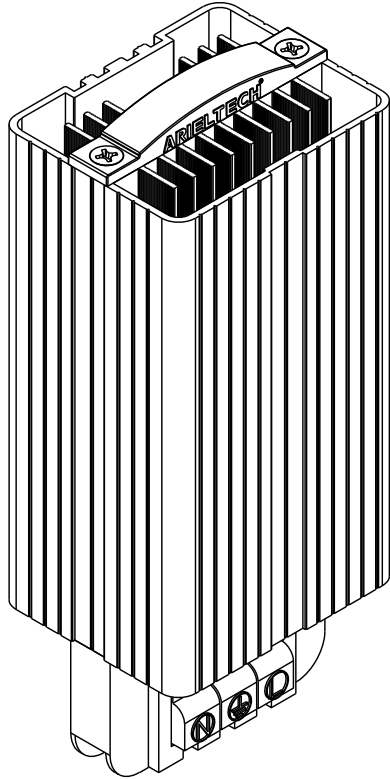

● All Dimensions : mm (Inch)

Model No.	X	Y
HEATEC-35	78±0.5 mm (3 1/16"±3 15/16")	20±1 mm (13/16"±1/16")
HEATEC-45	78±0.5 mm (3 1/16"±3 15/16")	20±1 mm (13/16"±1/16")
HEATEC-60	148±0.5mm (5 13/16"±3 15/16")	55±1 mm (2 3/16"±1/16")
HEATEC-80	148±0.5mm (5 13/16"±3 15/16")	55±1 mm (2 3/16"±1/16")
HEATEC-100	148±0.5mm (5 13/16"±3 15/16")	55±1 mm (2 3/16"±1/16")
HEATEC-130	198±0.5mm (7 13/16"±3 15/16")	55±1 mm (2 3/16"±1/16")
HEATEC-150	198±0.5mm (7 13/16"±3 15/16")	55±1 mm (2 3/16"±1/16")

## Technical Data

Heater Model No.	Power* (WATT)	Voltage (VAC/VDC)	Inrush Current 110/240 VAC	Dimensions mm (Inch)	Weight KG(lb)	Max surface temp °C (°F)
HEATEC-035	35	110-240	1.2 A/2.5 A	116x75x61 (4.57x2.95x2.4)	0.5 (1.1)	90 (194)
HEATEC-045	45	110-240	1.8 A/3.5 A	116x75x61 (4.57x2.95x2.4)	0.5 (1.1)	95 (203)
HEATEC-060	60	110-240	2.0 A/3.8 A	186x75x61 (7.32x2.95x2.4)	0.7 (1.55)	95 (203)
HEATEC-080	80	110-240	2.2 A/4.2 A	186x75x61 (7.32x2.95x2.4)	0.7 (1.55)	105 (221)
HEATEC-100	100	110-240	3.5 A/6.5 A	186x75x61 (7.32x2.95x2.4)	0.7 (1.55)	110 (230)
HEATEC-130	130	110-240	4.0 A/ 7.0 A	236x75x61 (9.29x2.95x2.4)	0.9 (2)	110 (230)
HEATEC-150	150	110-240	4.8 A/8.8 A	236x75x61 (9.29x2.95x2.4)	0.9 (2)	115 (239)

\* Attained values at 20°C (68 °F) ambient temperature and 240 VAC.

# THERMOELECTRIC COOLING UNIT

## COLTEC

### Certificates

- CE Compliant

### Application

Thermoelectric Cooling Units are used for the most demanding industries such as industrial and electronic enclosures, medical equipment, laboratory instruments, aerospace, semiconductors & telecommunications equipment. Uses range from simple food and beverage coolers for an afternoon picnic to extremely sophisticated temperature control systems in missiles and space vehicles. A thermoelectric cooling unit permits the lowering of the temperature of an object below ambient temperature as well as stabilizing the temperature of objects above ambient temperature. A thermoelectric cooler is different from a heat sink because it provides active cooling, unlike a heat sink, which provides only passive cooling. Ariel Technology Inc. provides a variety of solutions for different application as follows:

- **Air to Air** Thermoelectric Cooling unit (COLTECN series) Telecommunication Battery Temperature Control, Industry Equipment Power Cabinet Cooling, etc.
- **Air to Plate** Thermoelectric Cooling unit (COLTECAP series) Medical Devices, Instrument and Laboratory Test Equipment, Direct Contact Cooling Design, etc.
- **Air to Liquid** Thermoelectric Cooling unit (COLTECAL series) Medical Hairdressing Devices, Laser Equipment, or other needed cooling device applications.
- **Liquid to Liquid** Thermoelectric Cooling unit (COLTECLL series) LED Manufacturing Evaporating Systems, Analytic Instruments, etc.

### Features

- Zero maintenance, no filters, compressors, or refrigerant required
- Safe for the environment
- No air exchange between ambient and cabinet air
- Continuous worry-free operation
- Installs vertically or horizontally. Can be installed on any plate thickness by means of screws
- Uses quality ball bearing fans
- Standard direction airflow
- Ingress Protection is NEMA 12/ IP 55



CE



## Color

- RAL 9003 – White

## Advantages

Thermoelectric Cooling Units have no moving parts and do not require the use of chlorofluorocarbons. Therefore, they are safe for the environment, reliable, and virtually maintenance-free. They can be operated in any orientation and are ideal for cooling devices that might be sensitive to mechanical vibration. Their compact size also makes them ideal for applications that are size or weight limited, and where even the smallest compressor would have excess capacity.

### Air to Air Thermoelectric Cooling Unit (COLTECN series)

Model	Cooling Capacity	Voltage	Stable Current	Dimensions		Weight		Ambient Temp. Range	
	W	(Vdc)	(A)	(mm)	(Inch)	(Kg)	(lb)	(°C)	(°F)
COLTECN01512-55	19	12	2.2 ±10%	121x100x80	4.76x3.94x3.15	0.6	1.32	-10 TO +60	14 TO +140
COLTECN02512-55	25	12	2.5 ±10%	108X100X80	4.25X3.94X3.15	0.6	1.32	-10 TO +60	14 TO +140
COLTECN03512-55	35	12	3.9 ±10%	144X120X103	5.67X4.73X4.05	1.1	2.43	-10 TO +60	14 TO +140
COLTECN05012-55	50	12	8.2 ±10%	148X160X123	5.83X6.30X4.84	1.8	3.97	-10 TO +60	14 TO +140
COLTECN05024-55	50	24	4.0 ±10%	160X122X147	6.30X4.80X5.79	1.8	3.97	-10 TO +60	14 TO +140
COLTECN-08024-55	80	24	5.0 ±10%	241X156X210	9.49X6.14X8.27	2.8	6.17	-10 TO +60	14 TO +140
COLTECN10012-55	100	12	12.6 ±10%	241X156X210	9.49X6.14X8.27	2.8	6.17	-10 TO +60	14 TO +140
COLTECN10024-55	100	24	8.2 ±10%	200X180X89	7.87x7.09x7.09	3.0	6.61	-10 TO +60	14 TO +140
COLTECN10048-55	100	48	2.5 ±10%	200x180x180	7.87x7.09x7.09	3.0	6.61	-10 TO +60	14 TO +140
COLTECN10024-55	200 ±10%	24	12.5 ±10%	400X200X180	15.75X7.87X7.09	7.5	16.53	-10 TO +60	14 TO +140
COLTECN20048-55	200 ±10%	48	7.5 ±10%	400X200X180	15.75X7.87X7.09	7.5	16.53	10 TO +60	14 TO +140

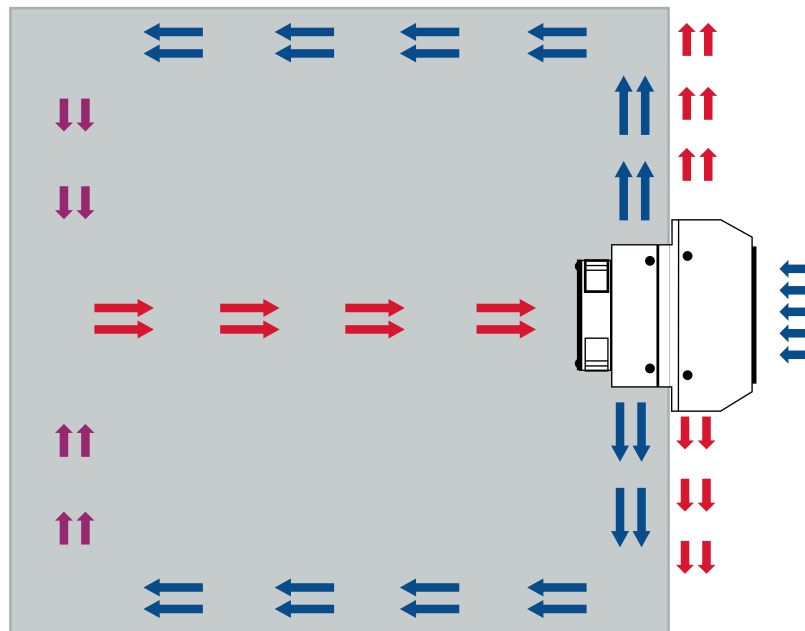

### Air to Plate Thermoelectric Cooling Unit (COLTECAP series)

Model	Cooling Capacity	Voltage	Stable Current	Dimensions		Weight		Ambient Temp. Range	
	(W)			(Vdc)	(A)	(mm)	(Inch)	(Kg)	(lb)
COLTECAP04012	42	12	4.1 ±10%	122X100X82	4.80X3.94X3.23	0.8	1.76	0 TO +60	32 to +140
COLTECAP05012	50	12	8.5 ±10%	160x122x82	6.30x4.80x3.23	1.1	2.43	0 TO +60	32 to +140
COLTECAP05024	50	24	4.3 ±10%	160x122x82	6.30x4.80x3.23	1.1	2.43	0 TO +60	32 to +140
COLTECAP08024	80	24	4.3 ±10%	203x155x152	7.99x6.10x4.98	3.6	7.94	0 TO +60	32 to +140

### Air to Liquid Thermoelectric Unit (COLTECAL series)

Model	Cooling Capacity	Voltage	Stable Current	Dimensions		Weight		Ambient Temp. Range	
	(W)			(Vdc)	(A)	(mm)	(Inch)	(Kg)	(lb)
COLTECAL05012	50	12	8.0 ±10%	160X120X84	6.30X4.7X3.3	1.5	3.30	-10 TO +55	14 to +131
COLTECAL05024	50	24	4.0 ±10%	160X120X84	6.30X4.7X3.3	1.5	3.30	-10 TO +55	14 to +131
COLTECAL08024	80	24	5.1 ±10%	203x155x147	7.99x6.10x5.8	3.1	6.83	-10 TO +55	14 to +131
COLTECAL10012	100	12	14.3 ±10%	203x155x147	7.99x6.10x5.8	3.1	6.83	-10 TO +55	14 to +131
COLTECAL10024	100	24	5.7 ±10%	124X122X97	8.66X6.10X3.8	1.8	3.96	-10 TO +55	14 to +131
COLTECAL15024	150	24	8.2 ±10%	160X155X150	6.3X6.1X5.9	3.1	6.83	-10 TO +55	14 to +131
COLTECAL30024	300	24	14 ±10%	275X161X161	10.83X6.34X6.34	5.0	10.91	-10 TO +55	14 to +131

### Liquid to Liquid Thermoelectric Cooling Unit (COLTECLL series)

Model	Cooling Capacity	Voltage	Stable Current	Dimensions		Weight		Ambient Temp. Range	
	(W)			(Vdc)	(A)	(mm)	(Inch)	(Kg)	(lb)
COLTECLL08024	80	24	4.2	200x36x60	7.87x1.42x2.36	1.2	2.65	0 TO +60	32 to +140
COLTECLL32024	320	24	13.3	240x102x60	9.45x4.00x2.36	3.7	8.16	0 TO +60	32 to +140



# Standard Warranty for All Products

## Ariel Technology, Inc. ("Manufacturer")

Ariel Technology Inc. is the manufacturer (the "Manufacturer") of the products (the "Products") contained within the Products Instruction Manual and Product Catalogues. This warranty solely applies to the Products manufactured by the Manufacturer.

Warranty Terms and Conditions ("Warranty Terms"):

1. The Manufacturer warrants that on the date of shipment the Products are of the kind and quality described herein and are free of non-conformities in workmanship and material.

Buyer's exclusive remedy for a nonconformity in any item of the Products shall be the replacement (at the Manufacturer's option) of the item and any affected part of the Products, provided: (a) the non conforming product failed during normal, intended and proper use as per the Product's Instruction Manual and Product Catalogue of such product; (b) the failure is not attributable to improper or unauthorized application, storage, handling, modification, installation or use; and (c) the Manufacturer is given the reasonable opportunity to inspect the non-conforming product.

2. The Manufacturer's obligation to repair or replace shall be in effect for a period of one (1) year from initial use of the Products but not more than eighteen (18) months from the Manufacturer's shipment of the Products, provided the Buyer has sent a written notice within that period of time to the Manufacturer that the Products do not conform to the above warranty. Any replaced Product shall be warranted for the remainder of the original period of notification set forth above, but in no event less than 12 months from repair or replacement. At its expense, the Buyer shall remove and ship to the Manufacturer any such nonconforming items and shall reinstall the replaced Product. The shipment address for the Manufacturer is: Unit 9- 1111 Gorham Street, Newmarket, ON L3Y 8X8. The Buyer shall grant the Manufacturer access to the Product (intended to be replaced) at all reasonable times in order for the Manufacturer to determine any nonconformity in the Product. The Manufacturer shall have the right of disposal of the Product replaced by it. If the Manufacturer is unable or unwilling to replace, or if replacement Product does not remedy the nonconformity, the Manufacturer and the Buyer shall negotiate an equitable adjustment in the purchase price, which may or may not include a full refund of the price of such nonconforming Product.

3. Except for as provided in the Products Instructions Manual, the Manufacturer does not warrant and is not responsible for:

(i) Failures, defects or limitations in performance caused by or due to, in whole or in part: a) power outages/failures or power surges, water or floods, snow, ice, weather conditions, such as excessive cold or hot temperatures, excessive humidity levels, accidents, use of Products in corrosive environments, failure caused by third parties actions, acts of God, or other such events outside the Manufacturer's control; b) customer's non-compliance with the Manufacturer's Products Instruction Manual and Product Catalogues, negligence, mishandling, improper use or storage, attempts to repair or alter the Products in any way with consulting the Manufacturer, and servicing of the Products; and c) use of Products in combination with other equipment or products which lack a qualified agency's approval for quality. Any alternations or modifications to the whole or a part of the Product without the Manufacturer's prior written authorization, voids this Warranty.

4. THE MANUFACTURER HEREBY DISCLAIMS ALL OTHER REPRESENTATIONS, CONDITIONS AND WARRANTIES, EXPRESS OR IMPLIED, INCLUDING THOSE CONTAINED IN THE SALES OF GOODS ACT, ONTARIO, R.S.O. 1990, c. S.1. AND THE CIVIL CODE OF QUEBEC, CQLR CCQ-1991. THE MANUFACTURER SPECIFICALLY DISCLAIMS, INCLUDING BY WAY OF EXAMPLE AND NOT LIMITATION, THE IMPLIED WARRANTIES OF TITLE, MERCHANTABILITY, NON-INFRINGEMENT AND FITNESS FOR A PARTICULAR PURPOSE. IN NO EVENT SHALL THE MANUFACTURER BE LIABLE FOR ANY INCIDENTAL, SPECIAL, CONSEQUENTIAL OR PUNITIVE DAMAGES, WHETHER ARISING IN CONTRACT, TORT OR OTHERWISE UNDER ANY LEGAL PRINCIPLE, THEORY OR LAWS, EVEN IF IT HAS BEEN ADVISED OF THE POSSIBILITY OF SUCH DAMAGES. THE LIMITATIONS SET FORTH HERE WILL APPLY EVEN IF THE REMEDIES OF ERROR CORRECTION, REPAIR OR REPLACEMENT, REPERFORMANCE OF SERVICES AND REFUND OF PAYMENTS COMPLETELY FAIL OF THEIR ESSENTIAL PURPOSE. NOTWITHSTANDING ANYTHING HEREIN TO THE CONTRARY, THE LIMIT OF MANUFACTURER'S LIABILITY (WHETHER IN CONTRACT, TORT, NEGLIGENCE, STRICT LIABILITY, BY STATUTE OR OTHERWISE) TO CUSTOMER OR TO ANY THIRD PARTY CONCERNING THE MANUFACTURER'S PRODUCTS SOLD TO CUSTOMER AND WARRANTED HEREUNDER, THE MANUFACTURER'S PERFORMANCE OR NONPERFORMANCE, OR IN ANY MANNER RELATED TO THIS STANDARD WARRANTY TERMS, FOR ANY AND ALL CLAIMS WILL NOT IN THE AGGREGATE EXCEED THE ACTUAL AMOUNTS RECEIVED BY MANUFACTURER FOR THE SPECIFIC PRODUCT WITH RESPECT TO WHICH SUCH CLAIM IS MADE.

5. Buyer and successors of Buyer are limited to the remedies specified in this warranty and shall have no others for a nonconformity in the Products. Buyer agrees that these remedies provide Buyer and its successors with a minimum adequate remedy and are their exclusive remedies, whether Buyer's or its successors' remedies are based on contract, warranty, tort (including negligence), strict liability, indemnity, or any other legal theory, and whether arising out of warranties, representations, instructions, installations, or non-conformities from any cause.

6. The Warranty Terms are governed by and shall be construed under the laws of Ontario, Canada. In case of any dispute that may arise between the customer and the Manufacturer, the Courts of Ontario shall have the sole jurisdiction to resolve such disputes. The Manufacturer and customer explicitly agree that the terms of Sales of Goods Act, Ontario, R.S.O. 1990, c.S.1, and the United Nations Convention on Contracts for the International the Sale of Goods does not apply to the parties or any transaction between the Manufacturer and the customer.

Ariel Technology Inc. Customer Support Number: 905-895-5900



# ARIELTECH®

9-1111 Gorham St, Newmarket  
Ontario, Canada L3Y 8X8  
(USA/Canada) Toll Free: 1-855-895-5900  
Tel: 905-895-5900 | Fax: 905-895-5960  
info@arieltech.ca | www.arieltech.ca